

OPÉRATIONS MIXTES (PÂQUES) (A)

Suivez le Lapin de Pâques jusqu'à son panier. Calculez chaque réponse tout au long du trajectoire.



$$\begin{array}{r} 90 \\ + 94 \\ \hline \end{array}$$

$$\begin{array}{r} 315 \\ \div 5 \\ \hline \end{array}$$

$$\begin{array}{r} 6 \\ + 66 \\ \hline \end{array}$$

$$\begin{array}{r} 99 \\ \times 3 \\ \hline \end{array}$$

$$\begin{array}{r} 50 \\ \times 90 \\ \hline \end{array}$$

$$\begin{array}{r} 546 \\ \div 13 \\ \hline \end{array}$$

$$\begin{array}{r} 11 \\ + 55 \\ \hline \end{array}$$

$$\begin{array}{r} 5184 \\ \div 64 \\ \hline \end{array}$$

$$\begin{array}{r} 12 \\ + 20 \\ \hline \end{array}$$

$$\begin{array}{r} 15 \\ \times 34 \\ \hline \end{array}$$

$$\begin{array}{r} 168 \\ - 92 \\ \hline \end{array}$$

$$\begin{array}{r} 88 \\ + 71 \\ \hline \end{array}$$

$$\begin{array}{r} 151 \\ - 52 \\ \hline \end{array}$$

$$\begin{array}{r} 57 \\ + 26 \\ \hline \end{array}$$

$$\begin{array}{r} 420 \\ \div 12 \\ \hline \end{array}$$

$$\begin{array}{r} 9024 \\ \div 96 \\ \hline \end{array}$$

$$\begin{array}{r} 7298 \\ \div 89 \\ \hline \end{array}$$

$$\begin{array}{r} 44 \\ - 29 \\ \hline \end{array}$$

$$\begin{array}{r} 175 \\ - 82 \\ \hline \end{array}$$

$$\begin{array}{r} 136 \\ - 71 \\ \hline \end{array}$$

$$\begin{array}{r} 81 \\ - 17 \\ \hline \end{array}$$

$$\begin{array}{r} 88 \\ - 43 \\ \hline \end{array}$$

$$\begin{array}{r} 9 \\ \times 23 \\ \hline \end{array}$$

$$\begin{array}{r} 5980 \\ \div 65 \\ \hline \end{array}$$

$$\begin{array}{r} 4736 \\ \div 74 \\ \hline \end{array}$$



Vous l'avez fait!
Résultats: ____ sur 25

OPÉRATIONS MIXTES (PÂQUES) (A) RÉPONSES

Suivez le Lapin de Pâques jusqu'à son panier. Calculez chaque réponse tout au long du trajectoire.

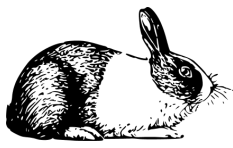

$$\begin{array}{r} 90 \\ + 94 \\ \hline \end{array}$$

$$\begin{array}{r} 315 \\ \div 5 \\ \hline \end{array}$$

$$\begin{array}{r} 6 \\ + 66 \\ \hline \end{array}$$

184

63

72

$$\begin{array}{r} 99 \\ \times 3 \\ \hline \end{array}$$

$$\begin{array}{r} 50 \\ \times 90 \\ \hline \end{array}$$

$$\begin{array}{r} 546 \\ \div 13 \\ \hline \end{array}$$

$$\begin{array}{r} 11 \\ + 55 \\ \hline \end{array}$$

297

4500

42

66

$$\begin{array}{r} 5184 \\ \div 64 \\ \hline \end{array}$$

$$\begin{array}{r} 12 \\ + 20 \\ \hline \end{array}$$

$$\begin{array}{r} 15 \\ \times 34 \\ \hline \end{array}$$

$$\begin{array}{r} 168 \\ - 92 \\ \hline \end{array}$$

81

32

510

76

$$\begin{array}{r} 88 \\ + 71 \\ \hline \end{array}$$

$$\begin{array}{r} 151 \\ - 52 \\ \hline \end{array}$$

$$\begin{array}{r} 57 \\ + 26 \\ \hline \end{array}$$

$$\begin{array}{r} 420 \\ \div 12 \\ \hline \end{array}$$

159

99

83

35

$$\begin{array}{r} 9024 \\ \div 96 \\ \hline \end{array}$$

$$\begin{array}{r} 7298 \\ \div 89 \\ \hline \end{array}$$

$$\begin{array}{r} 44 \\ - 29 \\ \hline \end{array}$$

$$\begin{array}{r} 175 \\ - 82 \\ \hline \end{array}$$

94

82

15

93

$$\begin{array}{r} 136 \\ - 71 \\ \hline \end{array}$$

$$\begin{array}{r} 81 \\ - 17 \\ \hline \end{array}$$

$$\begin{array}{r} 88 \\ - 43 \\ \hline \end{array}$$

$$\begin{array}{r} 9 \\ \times 23 \\ \hline \end{array}$$

65

64

45

207

$$\begin{array}{r} 5980 \\ \div 65 \\ \hline \end{array}$$

$$\begin{array}{r} 4736 \\ \div 74 \\ \hline \end{array}$$

92

64



Vous l'avez fait!
Résultats: ___ sur 25

OPÉRATIONS MIXTES (PÂQUES) (B)

Suivez le Lapin de Pâques jusqu'à son panier. Calculez chaque réponse tout au long du trajectoire.



$$\begin{array}{r} 77 \\ + 12 \\ \hline \end{array}$$

$$\begin{array}{r} 61 \\ + 62 \\ \hline \end{array}$$

$$\begin{array}{r} 11 \\ \times 54 \\ \hline \end{array}$$

$$\begin{array}{r} 94 \\ \times 8 \\ \hline \end{array}$$

$$\begin{array}{r} 89 \\ \times 59 \\ \hline \end{array}$$

$$\begin{array}{r} 4221 \\ \div 67 \\ \hline \end{array}$$

$$\begin{array}{r} 4472 \\ \div 52 \\ \hline \end{array}$$

$$\begin{array}{r} 87 \\ + 94 \\ \hline \end{array}$$

$$\begin{array}{r} 33 \\ + 78 \\ \hline \end{array}$$

$$\begin{array}{r} 1960 \\ \div 49 \\ \hline \end{array}$$

$$\begin{array}{r} 30 \\ - 8 \\ \hline \end{array}$$

$$\begin{array}{r} 3 \\ \times 19 \\ \hline \end{array}$$

$$\begin{array}{r} 3055 \\ \div 47 \\ \hline \end{array}$$

$$\begin{array}{r} 94 \\ - 14 \\ \hline \end{array}$$

$$\begin{array}{r} 42 \\ + 68 \\ \hline \end{array}$$

$$\begin{array}{r} 64 \\ + 32 \\ \hline \end{array}$$

$$\begin{array}{r} 38 \\ - 32 \\ \hline \end{array}$$

$$\begin{array}{r} 3792 \\ \div 48 \\ \hline \end{array}$$

$$\begin{array}{r} 61 \\ + 1 \\ \hline \end{array}$$

$$\begin{array}{r} 48 \\ + 83 \\ \hline \end{array}$$

$$\begin{array}{r} 126 \\ - 75 \\ \hline \end{array}$$

$$\begin{array}{r} 70 \\ \times 49 \\ \hline \end{array}$$

$$\begin{array}{r} 2340 \\ \div 26 \\ \hline \end{array}$$

$$\begin{array}{r} 40 \\ + 23 \\ \hline \end{array}$$

$$\begin{array}{r} 43 \\ + 42 \\ \hline \end{array}$$



Vous l'avez fait!
Résultats: ____ sur 25

OPÉRATIONS MIXTES (PÂQUES) (B) RÉPONSES

Suivez le Lapin de Pâques jusqu'à son panier. Calculez chaque réponse tout au long du trajectoire.



$$\begin{array}{r} 77 \\ + 12 \\ \hline \end{array}$$

89

$$\begin{array}{r} 61 \\ + 62 \\ \hline \end{array}$$

123

$$\begin{array}{r} 11 \\ \times 54 \\ \hline \end{array}$$

594

$$\begin{array}{r} 94 \\ \times 8 \\ \hline \end{array}$$

752

$$\begin{array}{r} 89 \\ \times 59 \\ \hline \end{array}$$

5251

$$\begin{array}{r} 4221 \\ \div 67 \\ \hline \end{array}$$

63

$$\begin{array}{r} 4472 \\ \div 52 \\ \hline \end{array}$$

86

$$\begin{array}{r} 87 \\ + 94 \\ \hline \end{array}$$

181

$$\begin{array}{r} 33 \\ + 78 \\ \hline \end{array}$$

111

$$\begin{array}{r} 1960 \\ \div 49 \\ \hline \end{array}$$

40

$$\begin{array}{r} 30 \\ - 8 \\ \hline \end{array}$$

22

$$\begin{array}{r} 3 \\ \times 19 \\ \hline \end{array}$$

57

$$\begin{array}{r} 3055 \\ \div 47 \\ \hline \end{array}$$

65

$$\begin{array}{r} 94 \\ - 14 \\ \hline \end{array}$$

80

$$\begin{array}{r} 42 \\ + 68 \\ \hline \end{array}$$

110

$$\begin{array}{r} 64 \\ + 32 \\ \hline \end{array}$$

96

$$\begin{array}{r} 38 \\ - 32 \\ \hline \end{array}$$

6

$$\begin{array}{r} 3792 \\ \div 48 \\ \hline \end{array}$$

79

$$\begin{array}{r} 61 \\ + 1 \\ \hline \end{array}$$

62

$$\begin{array}{r} 48 \\ + 83 \\ \hline \end{array}$$

131

$$\begin{array}{r} 126 \\ - 75 \\ \hline \end{array}$$

51

$$\begin{array}{r} 70 \\ \times 49 \\ \hline \end{array}$$

3430

$$\begin{array}{r} 2340 \\ \div 26 \\ \hline \end{array}$$

90

$$\begin{array}{r} 40 \\ + 23 \\ \hline \end{array}$$

63

$$\begin{array}{r} 43 \\ + 42 \\ \hline \end{array}$$

85



Vous l'avez fait!
Résultats: ___ sur 25

OPÉRATIONS MIXTES (PÂQUES) (C)

Suivez le Lapin de Pâques jusqu'à son panier. Calculez chaque réponse tout au long du trajectoire.



$$\begin{array}{r} 91 \\ + 63 \\ \hline \end{array}$$

$$\begin{array}{r} 69 \\ - 48 \\ \hline \end{array}$$

$$\begin{array}{r} 100 \\ - 83 \\ \hline \end{array}$$

$$\begin{array}{r} 45 \\ + 58 \\ \hline \end{array}$$

$$\begin{array}{r} 37 \\ \times 92 \\ \hline \end{array}$$

$$\begin{array}{r} 4464 \\ \div 62 \\ \hline \end{array}$$

$$\begin{array}{r} 3485 \\ \div 41 \\ \hline \end{array}$$

$$\begin{array}{r} 2958 \\ \div 58 \\ \hline \end{array}$$

$$\begin{array}{r} 13 \\ - 10 \\ \hline \end{array}$$

$$\begin{array}{r} 27 \\ + 75 \\ \hline \end{array}$$

$$\begin{array}{r} 110 \\ - 63 \\ \hline \end{array}$$

$$\begin{array}{r} 37 \\ \times 31 \\ \hline \end{array}$$

$$\begin{array}{r} 76 \\ \times 86 \\ \hline \end{array}$$

$$\begin{array}{r} 176 \\ - 81 \\ \hline \end{array}$$

$$\begin{array}{r} 2640 \\ \div 44 \\ \hline \end{array}$$

$$\begin{array}{r} 86 \\ \times 86 \\ \hline \end{array}$$

$$\begin{array}{r} 76 \\ - 35 \\ \hline \end{array}$$

$$\begin{array}{r} 96 \\ + 50 \\ \hline \end{array}$$

$$\begin{array}{r} 40 \\ + 53 \\ \hline \end{array}$$

$$\begin{array}{r} 53 \\ - 46 \\ \hline \end{array}$$

$$\begin{array}{r} 25 \\ - 19 \\ \hline \end{array}$$

$$\begin{array}{r} 7238 \\ \div 94 \\ \hline \end{array}$$

$$\begin{array}{r} 69 \\ \times 5 \\ \hline \end{array}$$

$$\begin{array}{r} 70 \\ + 11 \\ \hline \end{array}$$

$$\begin{array}{r} 4081 \\ \div 77 \\ \hline \end{array}$$



Vous l'avez fait!

Résultats: ____ sur 25

OPÉRATIONS MIXTES (PÂQUES) (C) RÉPONSES

Suivez le Lapin de Pâques jusqu'à son panier. Calculez chaque réponse tout au long du trajectoire.



$$\begin{array}{r} 91 \\ + 63 \\ \hline \end{array}$$

154

$$\begin{array}{r} 69 \\ - 48 \\ \hline \end{array}$$

21

$$\begin{array}{r} 100 \\ - 83 \\ \hline \end{array}$$

17

$$\begin{array}{r} 45 \\ + 58 \\ \hline \end{array}$$

103

$$\begin{array}{r} 37 \\ \times 92 \\ \hline \end{array}$$

3404

$$\begin{array}{r} 4464 \\ \div 62 \\ \hline \end{array}$$

72

$$\begin{array}{r} 3485 \\ \div 41 \\ \hline \end{array}$$

85

$$\begin{array}{r} 2958 \\ \div 58 \\ \hline \end{array}$$

51

$$\begin{array}{r} 13 \\ - 10 \\ \hline \end{array}$$

3

$$\begin{array}{r} 27 \\ + 75 \\ \hline \end{array}$$

102

$$\begin{array}{r} 110 \\ - 63 \\ \hline \end{array}$$

47

$$\begin{array}{r} 37 \\ \times 31 \\ \hline \end{array}$$

1147

$$\begin{array}{r} 76 \\ \times 86 \\ \hline \end{array}$$

6536

$$\begin{array}{r} 176 \\ - 81 \\ \hline \end{array}$$

95

$$\begin{array}{r} 2640 \\ \div 44 \\ \hline \end{array}$$

60

$$\begin{array}{r} 86 \\ \times 86 \\ \hline \end{array}$$

7396

$$\begin{array}{r} 76 \\ - 35 \\ \hline \end{array}$$

41

$$\begin{array}{r} 96 \\ + 50 \\ \hline \end{array}$$

146

$$\begin{array}{r} 40 \\ + 53 \\ \hline \end{array}$$

93

$$\begin{array}{r} 53 \\ - 46 \\ \hline \end{array}$$

7

$$\begin{array}{r} 25 \\ - 19 \\ \hline \end{array}$$

6

$$\begin{array}{r} 7238 \\ \div 94 \\ \hline \end{array}$$

77

$$\begin{array}{r} 69 \\ \times 5 \\ \hline \end{array}$$

345

$$\begin{array}{r} 70 \\ + 11 \\ \hline \end{array}$$

81

$$\begin{array}{r} 4081 \\ \div 77 \\ \hline \end{array}$$

53



Vous l'avez fait!
Résultats: ____ sur 25

OPÉRATIONS MIXTES (PÂQUES) (1)

Suivez le Lapin de Pâques jusqu'à son panier. Calculez chaque réponse tout au long du trajectoire.

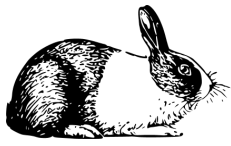

$$\begin{array}{r} 5 \\ \times 25 \\ \hline \end{array}$$

 \rightarrow

$$\begin{array}{r} 72 \\ \div 8 \\ \hline \end{array}$$

 \rightarrow

$$\begin{array}{r} 46 \\ + 58 \\ \hline \end{array}$$

$$\begin{array}{r} 6732 \\ \div 99 \\ \hline \end{array}$$

 \leftarrow

$$\begin{array}{r} 75 \\ + 84 \\ \hline \end{array}$$

 \leftarrow

$$\begin{array}{r} 476 \\ \div 34 \\ \hline \end{array}$$

 \leftarrow

$$\begin{array}{r} 1376 \\ \div 32 \\ \hline \end{array}$$

$$\begin{array}{r} 90 \\ + 61 \\ \hline \end{array}$$

 \rightarrow

$$\begin{array}{r} 66 \\ \times 28 \\ \hline \end{array}$$

 \rightarrow

$$\begin{array}{r} 84 \\ \div 4 \\ \hline \end{array}$$

 \rightarrow

$$\begin{array}{r} 441 \\ \div 63 \\ \hline \end{array}$$

$$\begin{array}{r} 103 \\ - 94 \\ \hline \end{array}$$

 \leftarrow

$$\begin{array}{r} 90 \\ \times 5 \\ \hline \end{array}$$

 \leftarrow

$$\begin{array}{r} 35 \\ \times 61 \\ \hline \end{array}$$

 \leftarrow

$$\begin{array}{r} 27 \\ + 12 \\ \hline \end{array}$$

$$\begin{array}{r} 95 \\ + 49 \\ \hline \end{array}$$

 \rightarrow

$$\begin{array}{r} 133 \\ \div 19 \\ \hline \end{array}$$

 \rightarrow

$$\begin{array}{r} 4480 \\ \div 56 \\ \hline \end{array}$$

 \rightarrow

$$\begin{array}{r} 1700 \\ \div 68 \\ \hline \end{array}$$

$$\begin{array}{r} 51 \\ \times 46 \\ \hline \end{array}$$

 \leftarrow

$$\begin{array}{r} 148 \\ - 53 \\ \hline \end{array}$$

 \leftarrow

$$\begin{array}{r} 98 \\ + 5 \\ \hline \end{array}$$

 \leftarrow

$$\begin{array}{r} 4320 \\ \div 90 \\ \hline \end{array}$$

$$\begin{array}{r} 106 \\ - 62 \\ \hline \end{array}$$

 \rightarrow

$$\begin{array}{r} 31 \\ + 83 \\ \hline \end{array}$$



Vous l'avez fait!
Résultats: ___ sur 25

OPÉRATIONS MIXTES (PÂQUES) (D) RÉPONSES

Suivez le Lapin de Pâques jusqu'à son panier. Calculez chaque réponse tout au long du trajectoire.



$$\begin{array}{r} 5 \\ \times 25 \\ \hline \end{array}$$

125

$$\begin{array}{r} 72 \\ \div 8 \\ \hline \end{array}$$

9

$$\begin{array}{r} 46 \\ + 58 \\ \hline \end{array}$$

104

$$\begin{array}{r} 6732 \\ \div 99 \\ \hline \end{array}$$

68

$$\begin{array}{r} 75 \\ + 84 \\ \hline \end{array}$$

159

$$\begin{array}{r} 476 \\ \div 34 \\ \hline \end{array}$$

14

$$\begin{array}{r} 1376 \\ \div 32 \\ \hline \end{array}$$

43

$$\begin{array}{r} 90 \\ + 61 \\ \hline \end{array}$$

151

$$\begin{array}{r} 66 \\ \times 28 \\ \hline \end{array}$$

1848

$$\begin{array}{r} 84 \\ \div 4 \\ \hline \end{array}$$

21

$$\begin{array}{r} 441 \\ \div 63 \\ \hline \end{array}$$

7

$$\begin{array}{r} 103 \\ - 94 \\ \hline \end{array}$$

9

$$\begin{array}{r} 90 \\ \times 5 \\ \hline \end{array}$$

450

$$\begin{array}{r} 35 \\ \times 61 \\ \hline \end{array}$$

2135

$$\begin{array}{r} 27 \\ + 12 \\ \hline \end{array}$$

39

$$\begin{array}{r} 95 \\ + 49 \\ \hline \end{array}$$

144

$$\begin{array}{r} 133 \\ \div 19 \\ \hline \end{array}$$

7

$$\begin{array}{r} 4480 \\ \div 56 \\ \hline \end{array}$$

80

$$\begin{array}{r} 1700 \\ \div 68 \\ \hline \end{array}$$

25

$$\begin{array}{r} 51 \\ \times 46 \\ \hline \end{array}$$

2346

$$\begin{array}{r} 148 \\ - 53 \\ \hline \end{array}$$

95

$$\begin{array}{r} 98 \\ + 5 \\ \hline \end{array}$$

103

$$\begin{array}{r} 4320 \\ \div 90 \\ \hline \end{array}$$

48

$$\begin{array}{r} 106 \\ - 62 \\ \hline \end{array}$$

44

$$\begin{array}{r} 31 \\ + 83 \\ \hline \end{array}$$

114



Vous l'avez fait!
Résultats: ___ sur 25

OPÉRATIONS MIXTES (PÂQUES) CE

Suivez le Lapin de Pâques jusqu'à son panier. Calculez chaque réponse tout au long du trajectoire.



$$\begin{array}{r} 69 \\ + 94 \\ \hline \end{array}$$

$$\begin{array}{r} 58 \\ + 61 \\ \hline \end{array}$$

$$\begin{array}{r} 4 \\ \times 51 \\ \hline \end{array}$$

$$\begin{array}{r} 104 \\ - 7 \\ \hline \end{array}$$

$$\begin{array}{r} 62 \\ \times 68 \\ \hline \end{array}$$

$$\begin{array}{r} 87 \\ + 17 \\ \hline \end{array}$$

$$\begin{array}{r} 51 \\ + 75 \\ \hline \end{array}$$

$$\begin{array}{r} 99 \\ + 68 \\ \hline \end{array}$$

$$\begin{array}{r} 84 \\ - 26 \\ \hline \end{array}$$

$$\begin{array}{r} 67 \\ \times 4 \\ \hline \end{array}$$

$$\begin{array}{r} 184 \\ \div 23 \\ \hline \end{array}$$

$$\begin{array}{r} 45 \\ \times 70 \\ \hline \end{array}$$

$$\begin{array}{r} 1869 \\ \div 89 \\ \hline \end{array}$$

$$\begin{array}{r} 44 \\ + 55 \\ \hline \end{array}$$

$$\begin{array}{r} 1001 \\ \div 11 \\ \hline \end{array}$$

$$\begin{array}{r} 106 \\ - 40 \\ \hline \end{array}$$

$$\begin{array}{r} 735 \\ \div 15 \\ \hline \end{array}$$

$$\begin{array}{r} 6205 \\ \div 73 \\ \hline \end{array}$$

$$\begin{array}{r} 32 \\ \times 29 \\ \hline \end{array}$$

$$\begin{array}{r} 2 \\ \times 10 \\ \hline \end{array}$$

$$\begin{array}{r} 93 \\ \times 11 \\ \hline \end{array}$$

$$\begin{array}{r} 49 \\ \times 95 \\ \hline \end{array}$$

$$\begin{array}{r} 101 \\ - 65 \\ \hline \end{array}$$

$$\begin{array}{r} 61 \\ - 50 \\ \hline \end{array}$$

$$\begin{array}{r} 160 \\ - 89 \\ \hline \end{array}$$



Vous l'avez fait!
Résultats: ____ sur 25

OPÉRATIONS MIXTES (PÂQUES) (E) RÉPONSES

Suivez le Lapin de Pâques jusqu'à son panier. Calculez chaque réponse tout au long du trajectoire.



$$\begin{array}{r} 69 \\ + 94 \\ \hline 163 \end{array}$$

$$\begin{array}{r} 58 \\ + 61 \\ \hline 119 \end{array}$$

$$\begin{array}{r} 4 \\ \times 51 \\ \hline 204 \end{array}$$

$$\begin{array}{r} 104 \\ - 7 \\ \hline 97 \end{array}$$

$$\begin{array}{r} 62 \\ \times 68 \\ \hline 4216 \end{array}$$

$$\begin{array}{r} 87 \\ + 17 \\ \hline 104 \end{array}$$

$$\begin{array}{r} 51 \\ + 75 \\ \hline 126 \end{array}$$

$$\begin{array}{r} 99 \\ + 68 \\ \hline 167 \end{array}$$

$$\begin{array}{r} 84 \\ - 26 \\ \hline 58 \end{array}$$

$$\begin{array}{r} 67 \\ \times 4 \\ \hline 268 \end{array}$$

$$\begin{array}{r} 184 \\ \div 23 \\ \hline 8 \end{array}$$

$$\begin{array}{r} 45 \\ \times 70 \\ \hline 3150 \end{array}$$

$$\begin{array}{r} 1869 \\ \div 89 \\ \hline 21 \end{array}$$

$$\begin{array}{r} 44 \\ + 55 \\ \hline 99 \end{array}$$

$$\begin{array}{r} 1001 \\ \div 11 \\ \hline 91 \end{array}$$

$$\begin{array}{r} 106 \\ - 40 \\ \hline 66 \end{array}$$

$$\begin{array}{r} 735 \\ \div 15 \\ \hline 49 \end{array}$$

$$\begin{array}{r} 6205 \\ \div 73 \\ \hline 85 \end{array}$$

$$\begin{array}{r} 32 \\ \times 29 \\ \hline 928 \end{array}$$

$$\begin{array}{r} 2 \\ \times 10 \\ \hline 20 \end{array}$$

$$\begin{array}{r} 93 \\ \times 11 \\ \hline 1023 \end{array}$$

$$\begin{array}{r} 49 \\ \times 95 \\ \hline 4655 \end{array}$$

$$\begin{array}{r} 101 \\ - 65 \\ \hline 36 \end{array}$$

$$\begin{array}{r} 61 \\ - 50 \\ \hline 11 \end{array}$$

$$\begin{array}{r} 160 \\ - 89 \\ \hline 71 \end{array}$$



Vous l'avez fait!
Résultats: ____ sur 25

OPÉRATIONS MIXTES (PÂQUES) (F)

Suivez le Lapin de Pâques jusqu'à son panier. Calculez chaque réponse tout au long du trajectoire.

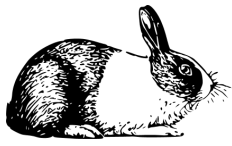

$$\begin{array}{r} 1740 \\ \div 87 \\ \hline \end{array}$$

$$\begin{array}{r} 122 \\ - 61 \\ \hline \end{array}$$

$$\begin{array}{r} 1768 \\ \div 34 \\ \hline \end{array}$$

$$\begin{array}{r} 176 \\ - 94 \\ \hline \end{array}$$

$$\begin{array}{r} 65 \\ - 25 \\ \hline \end{array}$$

$$\begin{array}{r} 62 \\ - 26 \\ \hline \end{array}$$

$$\begin{array}{r} 90 \\ \times 38 \\ \hline \end{array}$$

$$\begin{array}{r} 141 \\ - 55 \\ \hline \end{array}$$

$$\begin{array}{r} 3534 \\ \div 38 \\ \hline \end{array}$$

$$\begin{array}{r} 20 \\ \times 83 \\ \hline \end{array}$$

$$\begin{array}{r} 9 \\ \times 4 \\ \hline \end{array}$$

$$\begin{array}{r} 9 \\ \times 59 \\ \hline \end{array}$$

$$\begin{array}{r} 53 \\ - 51 \\ \hline \end{array}$$

$$\begin{array}{r} 98 \\ - 34 \\ \hline \end{array}$$

$$\begin{array}{r} 60 \\ - 24 \\ \hline \end{array}$$

$$\begin{array}{r} 6 \\ \times 33 \\ \hline \end{array}$$

$$\begin{array}{r} 2548 \\ \div 52 \\ \hline \end{array}$$

$$\begin{array}{r} 945 \\ \div 27 \\ \hline \end{array}$$

$$\begin{array}{r} 33 \\ + 79 \\ \hline \end{array}$$

$$\begin{array}{r} 3 \\ + 40 \\ \hline \end{array}$$

$$\begin{array}{r} 4257 \\ \div 99 \\ \hline \end{array}$$

$$\begin{array}{r} 1848 \\ \div 24 \\ \hline \end{array}$$

$$\begin{array}{r} 2277 \\ \div 23 \\ \hline \end{array}$$

$$\begin{array}{r} 80 \\ - 30 \\ \hline \end{array}$$

$$\begin{array}{r} 171 \\ \div 3 \\ \hline \end{array}$$



Vous l'avez fait!
Résultats: ____ sur 25

OPÉRATIONS MIXTES (PÂQUES) (F) RÉPONSES

Suivez le Lapin de Pâques jusqu'à son panier. Calculez chaque réponse tout au long du trajectoire.

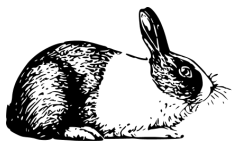

$$\begin{array}{r} 1740 \\ \div 87 \\ \hline \end{array}$$

20

$$\begin{array}{r} 122 \\ - 61 \\ \hline \end{array}$$

61

$$\begin{array}{r} 1768 \\ \div 34 \\ \hline \end{array}$$

52

$$\begin{array}{r} 176 \\ - 94 \\ \hline \end{array}$$

82

$$\begin{array}{r} 65 \\ - 25 \\ \hline \end{array}$$

40

$$\begin{array}{r} 62 \\ - 26 \\ \hline \end{array}$$

36

$$\begin{array}{r} 90 \\ \times 38 \\ \hline \end{array}$$

3420

$$\begin{array}{r} 141 \\ - 55 \\ \hline \end{array}$$

86

$$\begin{array}{r} 3534 \\ \div 38 \\ \hline \end{array}$$

93

$$\begin{array}{r} 20 \\ \times 83 \\ \hline \end{array}$$

1660

$$\begin{array}{r} 9 \\ \times 4 \\ \hline \end{array}$$

36

$$\begin{array}{r} 9 \\ \times 59 \\ \hline \end{array}$$

531

$$\begin{array}{r} 53 \\ - 51 \\ \hline \end{array}$$

2

$$\begin{array}{r} 98 \\ - 34 \\ \hline \end{array}$$

64

$$\begin{array}{r} 60 \\ - 24 \\ \hline \end{array}$$

36

$$\begin{array}{r} 6 \\ \times 33 \\ \hline \end{array}$$

198

$$\begin{array}{r} 2548 \\ \div 52 \\ \hline \end{array}$$

49

$$\begin{array}{r} 945 \\ \div 27 \\ \hline \end{array}$$

35

$$\begin{array}{r} 33 \\ + 79 \\ \hline \end{array}$$

112

$$\begin{array}{r} 3 \\ + 40 \\ \hline \end{array}$$

43

$$\begin{array}{r} 4257 \\ \div 99 \\ \hline \end{array}$$

43

$$\begin{array}{r} 1848 \\ \div 24 \\ \hline \end{array}$$

77

$$\begin{array}{r} 2277 \\ \div 23 \\ \hline \end{array}$$

99

$$\begin{array}{r} 80 \\ - 30 \\ \hline \end{array}$$

50

$$\begin{array}{r} 171 \\ \div 3 \\ \hline \end{array}$$

57



Vous l'avez fait!
Résultats: ___ sur 25

OPÉRATIONS MIXTES (PÂQUES) (6)

Suivez le Lapin de Pâques jusqu'à son panier. Calculez chaque réponse tout au long du trajectoire.

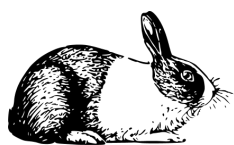

$$\begin{array}{r} 19 \\ + 16 \\ \hline \end{array}$$

$$\begin{array}{r} 85 \\ + 70 \\ \hline \end{array}$$

$$\begin{array}{r} 46 \\ \times 82 \\ \hline \end{array}$$

$$\begin{array}{r} 11 \\ + 11 \\ \hline \end{array}$$

$$\begin{array}{r} 747 \\ \div 9 \\ \hline \end{array}$$

$$\begin{array}{r} 51 \\ + 48 \\ \hline \end{array}$$

$$\begin{array}{r} 92 \\ \times 2 \\ \hline \end{array}$$

$$\begin{array}{r} 68 \\ + 8 \\ \hline \end{array}$$

$$\begin{array}{r} 14 \\ - 10 \\ \hline \end{array}$$

$$\begin{array}{r} 33 \\ - 13 \\ \hline \end{array}$$

$$\begin{array}{r} 30 \\ \times 2 \\ \hline \end{array}$$

$$\begin{array}{r} 2856 \\ \div 34 \\ \hline \end{array}$$

$$\begin{array}{r} 6723 \\ \div 81 \\ \hline \end{array}$$

$$\begin{array}{r} 950 \\ \div 38 \\ \hline \end{array}$$

$$\begin{array}{r} 53 \\ - 30 \\ \hline \end{array}$$

$$\begin{array}{r} 222 \\ \div 74 \\ \hline \end{array}$$

$$\begin{array}{r} 5688 \\ \div 79 \\ \hline \end{array}$$

$$\begin{array}{r} 53 \\ + 16 \\ \hline \end{array}$$

$$\begin{array}{r} 80 \\ + 10 \\ \hline \end{array}$$

$$\begin{array}{r} 154 \\ - 60 \\ \hline \end{array}$$

$$\begin{array}{r} 882 \\ \div 18 \\ \hline \end{array}$$

$$\begin{array}{r} 47 \\ \times 22 \\ \hline \end{array}$$

$$\begin{array}{r} 9 \\ \times 24 \\ \hline \end{array}$$

$$\begin{array}{r} 24 \\ - 23 \\ \hline \end{array}$$

$$\begin{array}{r} 396 \\ \div 99 \\ \hline \end{array}$$



Vous l'avez fait!
Résultats: ____ sur 25

OPÉRATIONS MIXTES (PÂQUES) (6) RÉPONSES

Suivez le Lapin de Pâques jusqu'à son panier. Calculez chaque réponse tout au long du trajectoire.



$$\begin{array}{r} 19 \\ + 16 \\ \hline \end{array}$$

35

$$\begin{array}{r} 85 \\ + 70 \\ \hline \end{array}$$

155

$$\begin{array}{r} 46 \\ \times 82 \\ \hline \end{array}$$

3772

$$\begin{array}{r} 11 \\ + 11 \\ \hline \end{array}$$

22

$$\begin{array}{r} 747 \\ \div 9 \\ \hline \end{array}$$

83

$$\begin{array}{r} 51 \\ + 48 \\ \hline \end{array}$$

99

$$\begin{array}{r} 92 \\ \times 2 \\ \hline \end{array}$$

184

$$\begin{array}{r} 68 \\ + 8 \\ \hline \end{array}$$

76

$$\begin{array}{r} 14 \\ - 10 \\ \hline \end{array}$$

4

$$\begin{array}{r} 33 \\ - 13 \\ \hline \end{array}$$

20

$$\begin{array}{r} 30 \\ \times 2 \\ \hline \end{array}$$

60

$$\begin{array}{r} 2856 \\ \div 34 \\ \hline \end{array}$$

84

$$\begin{array}{r} 6723 \\ \div 81 \\ \hline \end{array}$$

83

$$\begin{array}{r} 950 \\ \div 38 \\ \hline \end{array}$$

25

$$\begin{array}{r} 53 \\ - 30 \\ \hline \end{array}$$

23

$$\begin{array}{r} 222 \\ \div 74 \\ \hline \end{array}$$

3

$$\begin{array}{r} 5688 \\ \div 79 \\ \hline \end{array}$$

72

$$\begin{array}{r} 53 \\ + 16 \\ \hline \end{array}$$

69

$$\begin{array}{r} 80 \\ + 10 \\ \hline \end{array}$$

90

$$\begin{array}{r} 154 \\ - 60 \\ \hline \end{array}$$

94

$$\begin{array}{r} 882 \\ \div 18 \\ \hline \end{array}$$

49

$$\begin{array}{r} 47 \\ \times 22 \\ \hline \end{array}$$

1034

$$\begin{array}{r} 9 \\ \times 24 \\ \hline \end{array}$$

216

$$\begin{array}{r} 24 \\ - 23 \\ \hline \end{array}$$

1

$$\begin{array}{r} 396 \\ \div 99 \\ \hline \end{array}$$

4



Vous l'avez fait!
Résultats: ____ sur 25

OPÉRATIONS MIXTES (PÂQUES) (H)

Suivez le Lapin de Pâques jusqu'à son panier. Calculez chaque réponse tout au long du trajectoire.



$$\begin{array}{r} 82 \\ \times 32 \\ \hline \end{array}$$

$$\begin{array}{r} 53 \\ + 70 \\ \hline \end{array}$$

$$\begin{array}{r} 4875 \\ \div 75 \\ \hline \end{array}$$

$$\begin{array}{r} 95 \\ - 41 \\ \hline \end{array}$$

$$\begin{array}{r} 924 \\ \div 77 \\ \hline \end{array}$$

$$\begin{array}{r} 95 \\ - 55 \\ \hline \end{array}$$

$$\begin{array}{r} 5368 \\ \div 88 \\ \hline \end{array}$$

$$\begin{array}{r} 1575 \\ \div 63 \\ \hline \end{array}$$

$$\begin{array}{r} 5 \\ \times 11 \\ \hline \end{array}$$

$$\begin{array}{r} 66 \\ \times 86 \\ \hline \end{array}$$

$$\begin{array}{r} 97 \\ - 47 \\ \hline \end{array}$$

$$\begin{array}{r} 5467 \\ \div 77 \\ \hline \end{array}$$

$$\begin{array}{r} 1615 \\ \div 95 \\ \hline \end{array}$$

$$\begin{array}{r} 988 \\ \div 52 \\ \hline \end{array}$$

$$\begin{array}{r} 148 \\ - 74 \\ \hline \end{array}$$

$$\begin{array}{r} 61 \\ - 8 \\ \hline \end{array}$$

$$\begin{array}{r} 60 \\ \times 95 \\ \hline \end{array}$$

$$\begin{array}{r} 47 \\ + 14 \\ \hline \end{array}$$

$$\begin{array}{r} 37 \\ \times 26 \\ \hline \end{array}$$

$$\begin{array}{r} 120 \\ - 80 \\ \hline \end{array}$$

$$\begin{array}{r} 2132 \\ \div 41 \\ \hline \end{array}$$

$$\begin{array}{r} 13 \\ \times 90 \\ \hline \end{array}$$

$$\begin{array}{r} 96 \\ \times 81 \\ \hline \end{array}$$

$$\begin{array}{r} 810 \\ \div 81 \\ \hline \end{array}$$

$$\begin{array}{r} 1472 \\ \div 64 \\ \hline \end{array}$$



Vous l'avez fait!
Résultats: ___ sur 25

OPÉRATIONS MIXTES (PÂQUES) (H) RÉPONSES

Suivez le Lapin de Pâques jusqu'à son panier. Calculez chaque réponse tout au long du trajectoire.

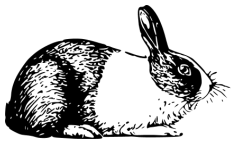

$$\begin{array}{r} 82 \\ \times 32 \\ \hline \end{array}$$
 $\begin{array}{r} 53 \\ + 70 \\ \hline \end{array}$
 $\begin{array}{r} 4875 \\ \div 75 \\ \hline \end{array}$

2624

123

65

$$\begin{array}{r} 95 \\ - 41 \\ \hline \end{array}$$
 $\begin{array}{r} 924 \\ \div 77 \\ \hline \end{array}$
 $\begin{array}{r} 95 \\ - 55 \\ \hline \end{array}$
 $\begin{array}{r} 5368 \\ \div 88 \\ \hline \end{array}$

54

12

40

61

$$\begin{array}{r} 1575 \\ \div 63 \\ \hline \end{array}$$
 $\begin{array}{r} 5 \\ \times 11 \\ \hline \end{array}$
 $\begin{array}{r} 66 \\ \times 86 \\ \hline \end{array}$
 $\begin{array}{r} 97 \\ - 47 \\ \hline \end{array}$

25

55

5676

50

$$\begin{array}{r} 5467 \\ \div 77 \\ \hline \end{array}$$
 $\begin{array}{r} 1615 \\ \div 95 \\ \hline \end{array}$
 $\begin{array}{r} 988 \\ \div 52 \\ \hline \end{array}$
 $\begin{array}{r} 148 \\ - 74 \\ \hline \end{array}$

71

17

19

74

$$\begin{array}{r} 61 \\ - 8 \\ \hline \end{array}$$
 $\begin{array}{r} 60 \\ \times 95 \\ \hline \end{array}$
 $\begin{array}{r} 47 \\ + 14 \\ \hline \end{array}$
 $\begin{array}{r} 37 \\ \times 26 \\ \hline \end{array}$

53

5700

61

962

$$\begin{array}{r} 120 \\ - 80 \\ \hline \end{array}$$
 $\begin{array}{r} 2132 \\ \div 41 \\ \hline \end{array}$
 $\begin{array}{r} 13 \\ \times 90 \\ \hline \end{array}$
 $\begin{array}{r} 96 \\ \times 81 \\ \hline \end{array}$

40

52

1170

7776

$$\begin{array}{r} 810 \\ \div 81 \\ \hline \end{array}$$
 $\begin{array}{r} 1472 \\ \div 64 \\ \hline \end{array}$

10

23



Vous l'avez fait!
Résultats: ___ sur 25

OPÉRATIONS MIXTES (PÂQUES) ①

Suivez le Lapin de Pâques jusqu'à son panier. Calculez chaque réponse tout au long du trajectoire.

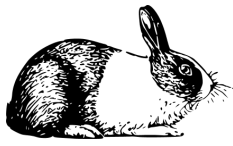

$$\begin{array}{r} 71 \\ + 62 \\ \hline \end{array}$$

$$\begin{array}{r} 83 \\ + 88 \\ \hline \end{array}$$

$$\begin{array}{r} 126 \\ - 29 \\ \hline \end{array}$$

$$\begin{array}{r} 118 \\ - 72 \\ \hline \end{array}$$

$$\begin{array}{r} 32 \\ \times 1 \\ \hline \end{array}$$

$$\begin{array}{r} 68 \\ \times 76 \\ \hline \end{array}$$

$$\begin{array}{r} 157 \\ - 66 \\ \hline \end{array}$$

$$\begin{array}{r} 82 \\ + 66 \\ \hline \end{array}$$

$$\begin{array}{r} 92 \\ \times 93 \\ \hline \end{array}$$

$$\begin{array}{r} 11 \\ + 82 \\ \hline \end{array}$$

$$\begin{array}{r} 70 \\ + 80 \\ \hline \end{array}$$

$$\begin{array}{r} 5226 \\ \div 78 \\ \hline \end{array}$$

$$\begin{array}{r} 79 \\ - 6 \\ \hline \end{array}$$

$$\begin{array}{r} 48 \\ + 31 \\ \hline \end{array}$$

$$\begin{array}{r} 93 \\ \times 44 \\ \hline \end{array}$$

$$\begin{array}{r} 3591 \\ \div 63 \\ \hline \end{array}$$

$$\begin{array}{r} 75 \\ \times 41 \\ \hline \end{array}$$

$$\begin{array}{r} 7 \\ + 2 \\ \hline \end{array}$$

$$\begin{array}{r} 95 \\ + 4 \\ \hline \end{array}$$

$$\begin{array}{r} 121 \\ - 87 \\ \hline \end{array}$$

$$\begin{array}{r} 5 \\ + 18 \\ \hline \end{array}$$

$$\begin{array}{r} 238 \\ \div 7 \\ \hline \end{array}$$

$$\begin{array}{r} 47 \\ - 30 \\ \hline \end{array}$$

$$\begin{array}{r} 1764 \\ \div 21 \\ \hline \end{array}$$

$$\begin{array}{r} 17 \\ + 18 \\ \hline \end{array}$$



Vous l'avez fait!
Résultats: ___ sur 25

OPÉRATIONS MIXTES (PÂQUES) (1) RÉPONSES

Suivez le Lapin de Pâques jusqu'à son panier. Calculez chaque réponse tout au long du trajectoire.

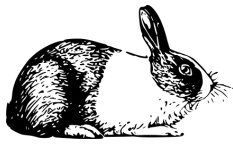

$$\begin{array}{r} 71 \\ + 62 \\ \hline 133 \end{array}$$

$$\begin{array}{r} 83 \\ + 88 \\ \hline 171 \end{array}$$

$$\begin{array}{r} 126 \\ - 29 \\ \hline 97 \end{array}$$

$$\begin{array}{r} 118 \\ - 72 \\ \hline 46 \end{array}$$

$$\begin{array}{r} 32 \\ \times 1 \\ \hline 32 \end{array}$$

$$\begin{array}{r} 68 \\ \times 76 \\ \hline 5168 \end{array}$$

$$\begin{array}{r} 157 \\ - 66 \\ \hline 91 \end{array}$$

$$\begin{array}{r} 82 \\ + 66 \\ \hline 148 \end{array}$$

$$\begin{array}{r} 92 \\ \times 93 \\ \hline 8556 \end{array}$$

$$\begin{array}{r} 11 \\ + 82 \\ \hline 93 \end{array}$$

$$\begin{array}{r} 70 \\ + 80 \\ \hline 150 \end{array}$$

$$\begin{array}{r} 5226 \\ \div 78 \\ \hline 67 \end{array}$$

$$\begin{array}{r} 79 \\ - 6 \\ \hline 73 \end{array}$$

$$\begin{array}{r} 48 \\ + 31 \\ \hline 79 \end{array}$$

$$\begin{array}{r} 93 \\ \times 44 \\ \hline 4092 \end{array}$$

$$\begin{array}{r} 3591 \\ \div 63 \\ \hline 57 \end{array}$$

$$\begin{array}{r} 75 \\ \times 41 \\ \hline 3075 \end{array}$$

$$\begin{array}{r} 7 \\ + 2 \\ \hline 9 \end{array}$$

$$\begin{array}{r} 95 \\ + 4 \\ \hline 99 \end{array}$$

$$\begin{array}{r} 121 \\ - 87 \\ \hline 34 \end{array}$$

$$\begin{array}{r} 5 \\ + 18 \\ \hline 23 \end{array}$$

$$\begin{array}{r} 238 \\ \div 7 \\ \hline 34 \end{array}$$

$$\begin{array}{r} 47 \\ - 30 \\ \hline 17 \end{array}$$

$$\begin{array}{r} 1764 \\ \div 21 \\ \hline 84 \end{array}$$

$$\begin{array}{r} 17 \\ + 18 \\ \hline 35 \end{array}$$



Vous l'avez fait!
Résultats: ___ sur 25

OPÉRATIONS MIXTES (PÂQUES) (1)

Suivez le Lapin de Pâques jusqu'à son panier. Calculez chaque réponse tout au long du trajectoire.



$$\begin{array}{r} 1360 \\ \div 17 \\ \hline \end{array}$$

$$\begin{array}{r} 3220 \\ \div 46 \\ \hline \end{array}$$

$$\begin{array}{r} 5 \\ + 72 \\ \hline \end{array}$$

$$\begin{array}{r} 1224 \\ \div 36 \\ \hline \end{array}$$

$$\begin{array}{r} 120 \\ - 55 \\ \hline \end{array}$$

$$\begin{array}{r} 6232 \\ \div 82 \\ \hline \end{array}$$

$$\begin{array}{r} 1188 \\ \div 36 \\ \hline \end{array}$$

$$\begin{array}{r} 60 \\ \times 23 \\ \hline \end{array}$$

$$\begin{array}{r} 60 \\ + 94 \\ \hline \end{array}$$

$$\begin{array}{r} 43 \\ + 59 \\ \hline \end{array}$$

$$\begin{array}{r} 44 \\ \times 47 \\ \hline \end{array}$$

$$\begin{array}{r} 56 \\ - 39 \\ \hline \end{array}$$

$$\begin{array}{r} 83 \\ \times 48 \\ \hline \end{array}$$

$$\begin{array}{r} 65 \\ + 37 \\ \hline \end{array}$$

$$\begin{array}{r} 17 \\ \times 15 \\ \hline \end{array}$$

$$\begin{array}{r} 16 \\ + 61 \\ \hline \end{array}$$

$$\begin{array}{r} 122 \\ - 68 \\ \hline \end{array}$$

$$\begin{array}{r} 27 \\ - 26 \\ \hline \end{array}$$

$$\begin{array}{r} 97 \\ - 83 \\ \hline \end{array}$$

$$\begin{array}{r} 96 \\ + 85 \\ \hline \end{array}$$

$$\begin{array}{r} 21 \\ + 51 \\ \hline \end{array}$$

$$\begin{array}{r} 18 \\ \times 35 \\ \hline \end{array}$$

$$\begin{array}{r} 54 \\ \times 9 \\ \hline \end{array}$$

$$\begin{array}{r} 3920 \\ \div 98 \\ \hline \end{array}$$

$$\begin{array}{r} 390 \\ \div 78 \\ \hline \end{array}$$



Vous l'avez fait!
Résultats: ____ sur 25

OPÉRATIONS MIXTES (PÂQUES) (J) RÉPONSES

Suivez le Lapin de Pâques jusqu'à son panier. Calculez chaque réponse tout au long du trajectoire.

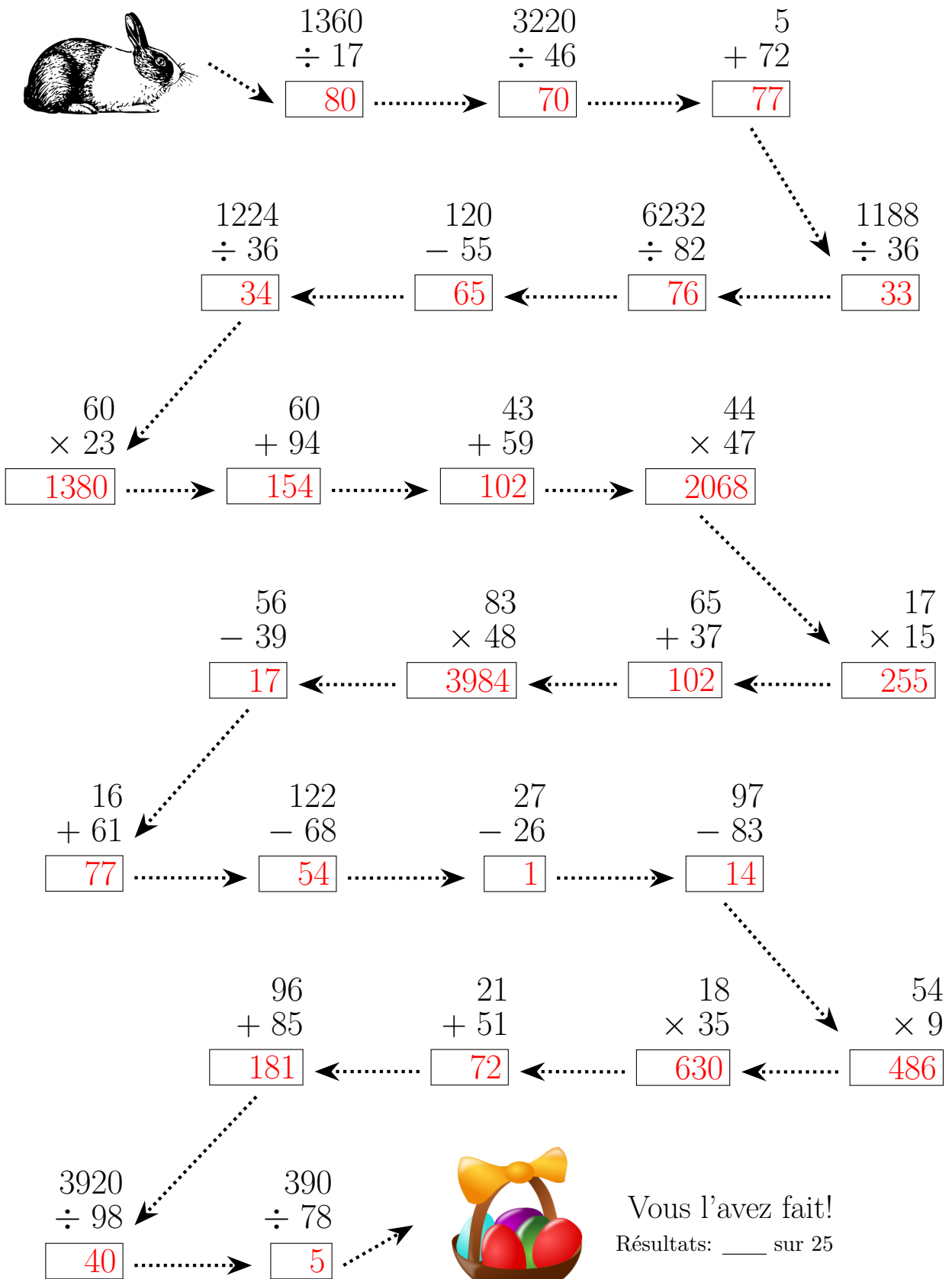

Vous l'avez fait!
Résultats: ____ sur 25