

Aire et Périmètre de Rectangles (A)

Trouvez l'aire et le périmètre de chaque rectangle.

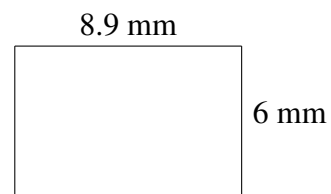
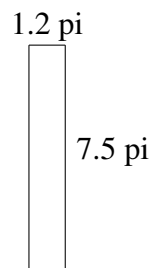
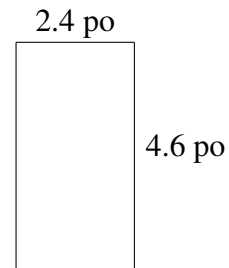
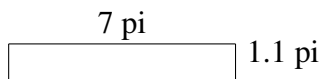
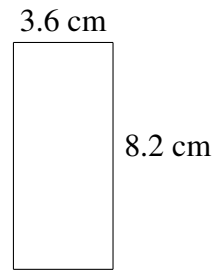
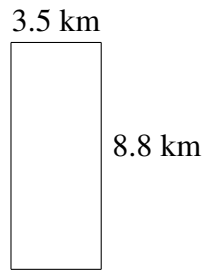

Aire et Périmètre de Rectangles (A) Solutions

Trouvez l'aire et le périmètre de chaque rectangle.

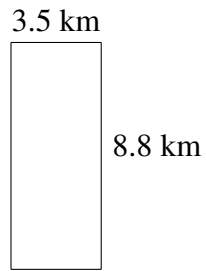

$$A = 30.80 \text{ km}^2$$
$$P = 24.6 \text{ km}$$

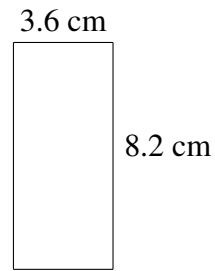

$$A = 29.52 \text{ cm}^2$$
$$P = 23.6 \text{ cm}$$

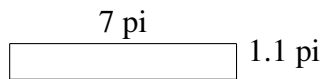

$$A = 7.7 \text{ pi}^2$$
$$P = 16.2 \text{ pi}$$

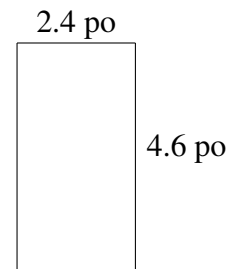

$$A = 11.04 \text{ po}^2$$
$$P = 14.0 \text{ po}$$

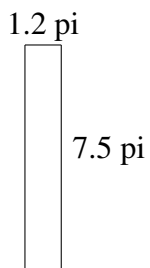

$$A = 9.00 \text{ pi}^2$$
$$P = 17.4 \text{ pi}$$

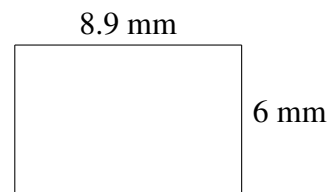

$$A = 53.4 \text{ mm}^2$$
$$P = 29.8 \text{ mm}$$

Aire et Périmètre de Rectangles (B)

Trouvez l'aire et le périmètre de chaque rectangle.

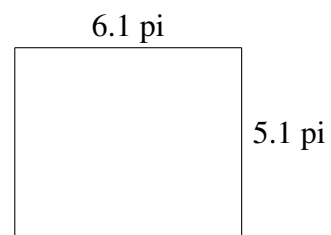
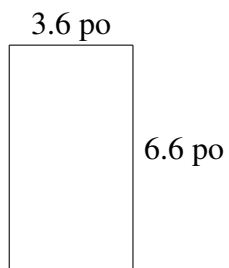
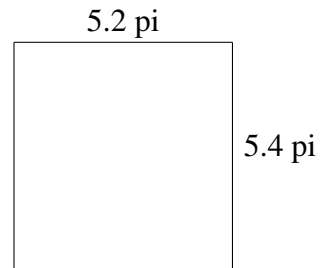
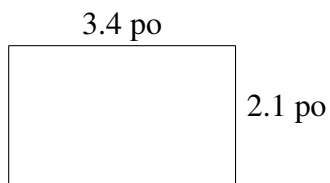
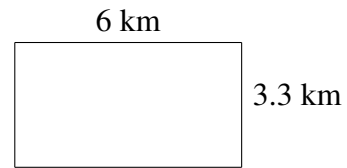
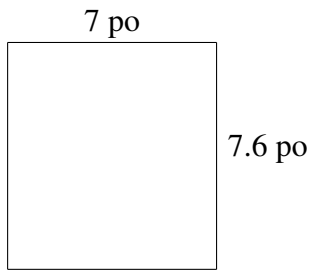

Aire et Périmètre de Rectangles (B) Solutions

Trouvez l'aire et le périmètre de chaque rectangle.

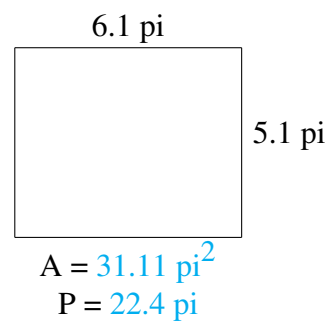
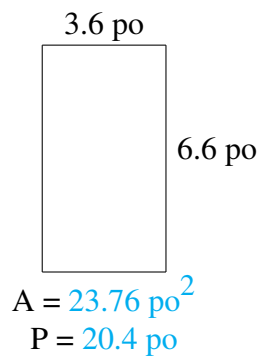
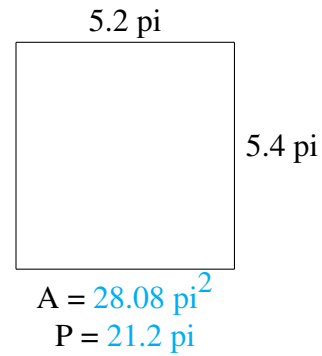
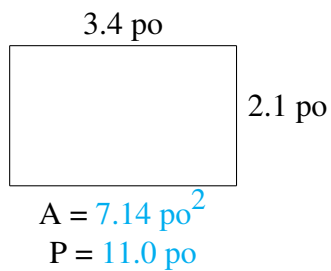
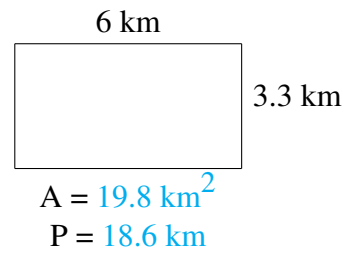
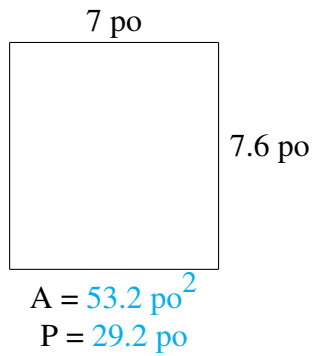

Aire et Périmètre de Rectangles (C)

Trouvez l'aire et le périmètre de chaque rectangle.

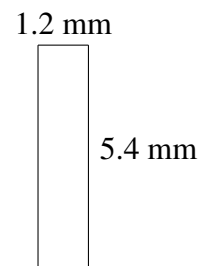
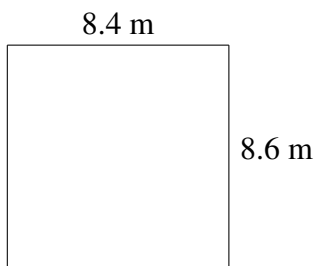
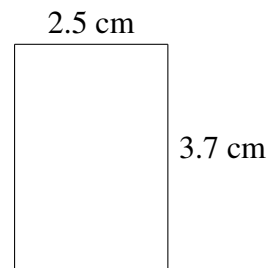
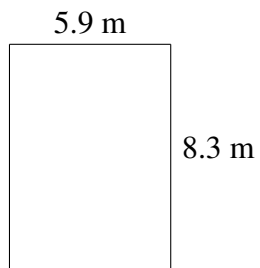
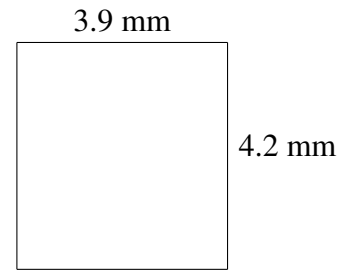
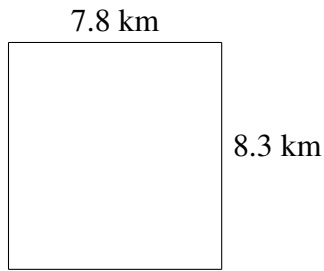

Aire et Périmètre de Rectangles (C) Solutions

Trouvez l'aire et le périmètre de chaque rectangle.

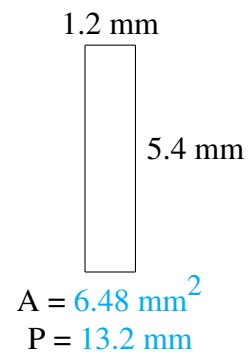
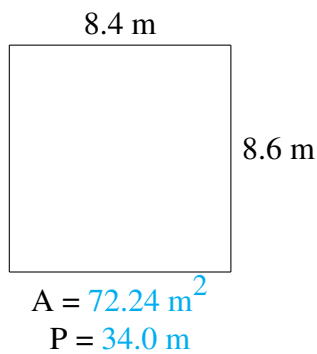
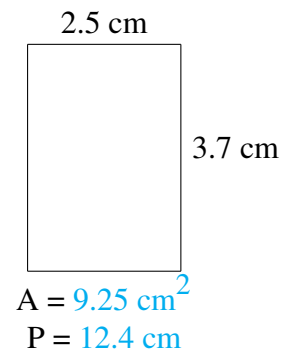
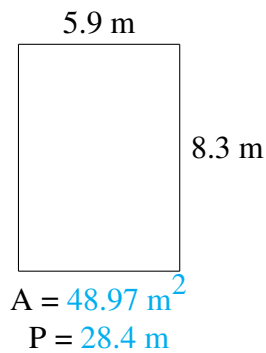
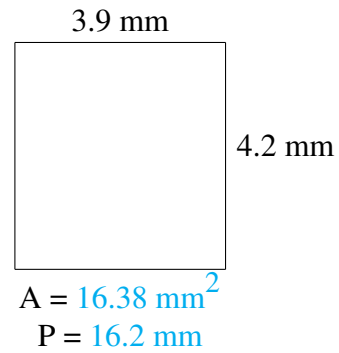
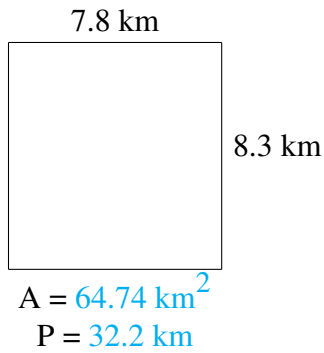

Aire et Périmètre de Rectangles (D)

Trouvez l'aire et le périmètre de chaque rectangle.

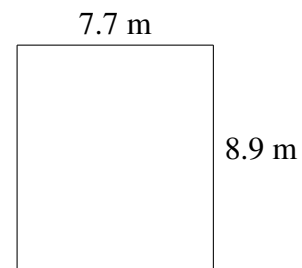
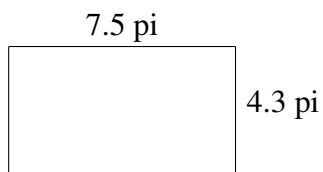
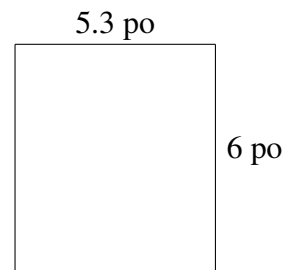
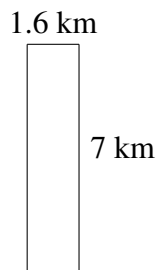
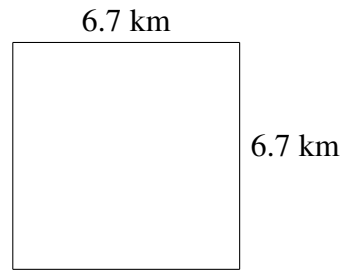
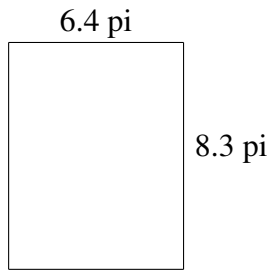

Aire et Périmètre de Rectangles (D) Solutions

Trouvez l'aire et le périmètre de chaque rectangle.

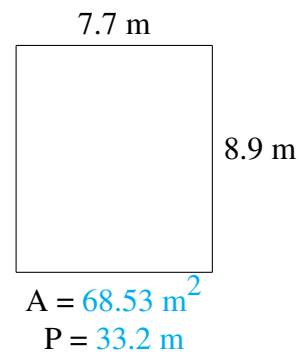
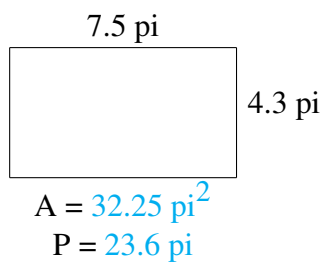
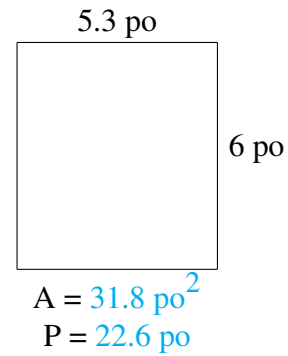
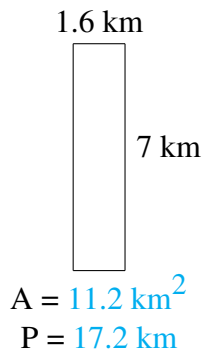
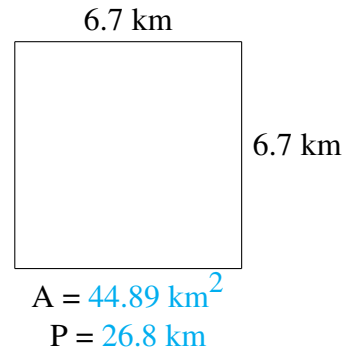
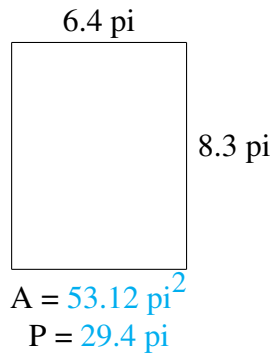

Aire et Périmètre de Rectangles (E)

Trouvez l'aire et le périmètre de chaque rectangle.

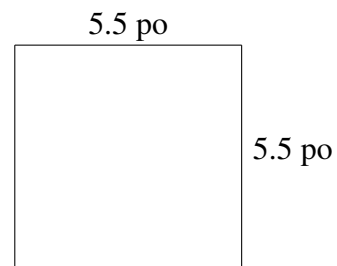
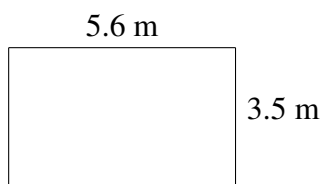
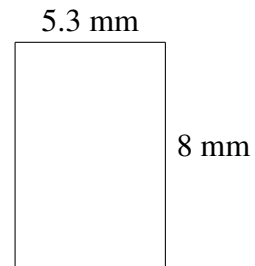
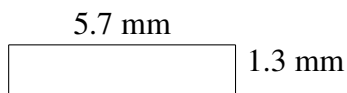
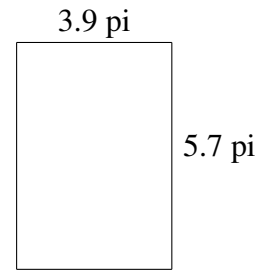
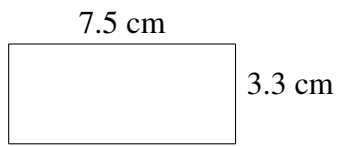

Aire et Périmètre de Rectangles (E) Solutions

Trouvez l'aire et le périmètre de chaque rectangle.

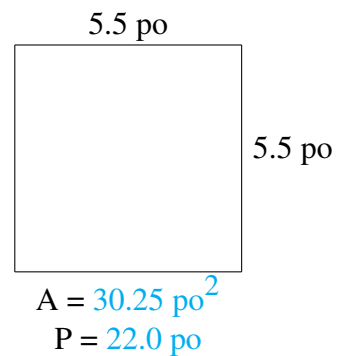
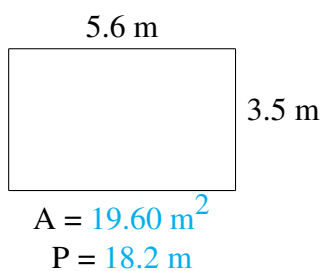
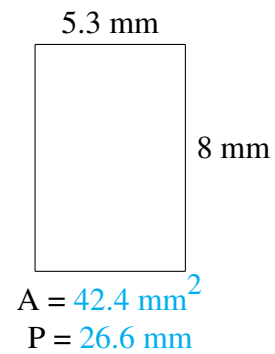
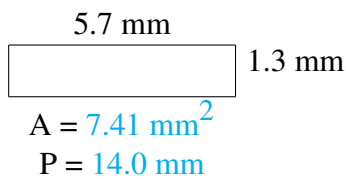
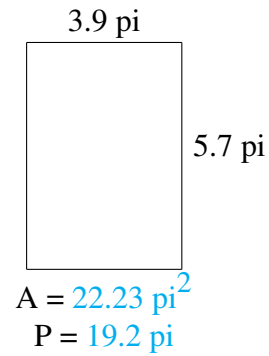
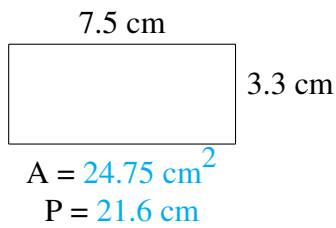

Aire et Périmètre de Rectangles (F)

Trouvez l'aire et le périmètre de chaque rectangle.

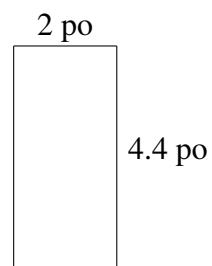
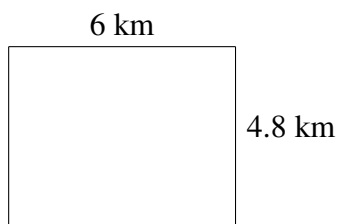
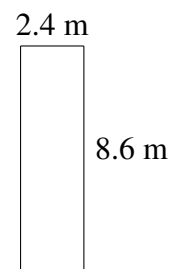
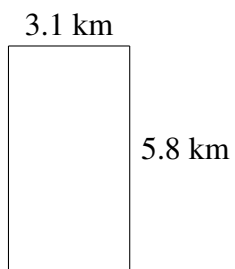
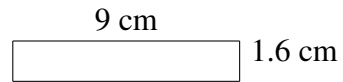
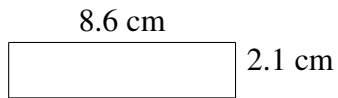

Aire et Périmètre de Rectangles (F) Solutions

Trouvez l'aire et le périmètre de chaque rectangle.

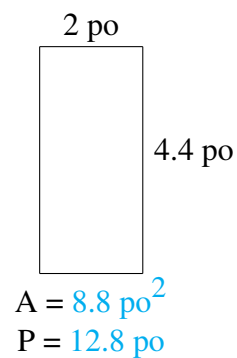
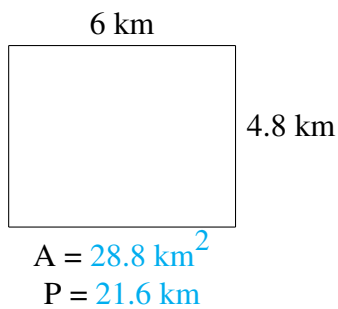
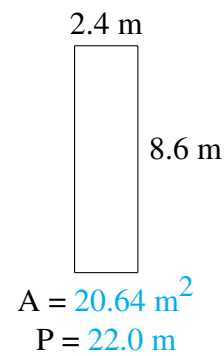
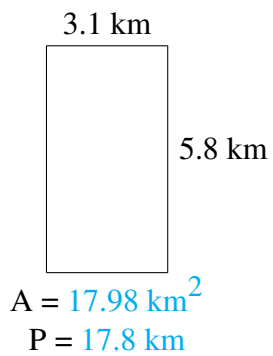
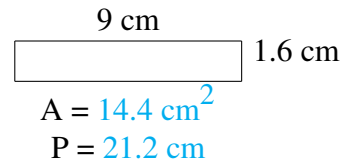
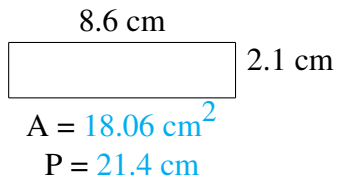

Aire et Périmètre de Rectangles (G)

Trouvez l'aire et le périmètre de chaque rectangle.

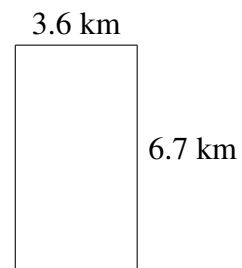
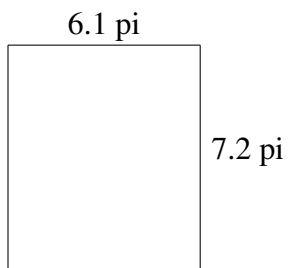
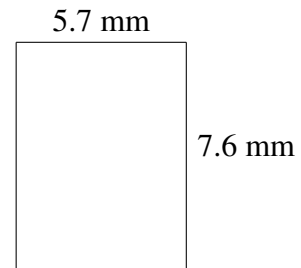
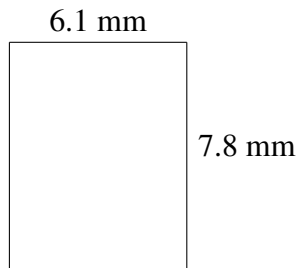
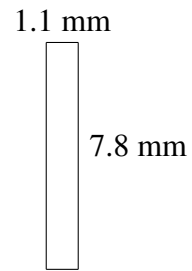
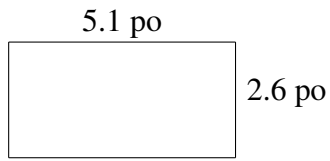

Aire et Périmètre de Rectangles (G) Solutions

Trouvez l'aire et le périmètre de chaque rectangle.

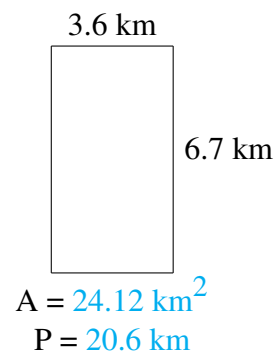
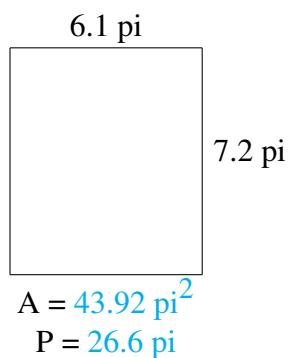
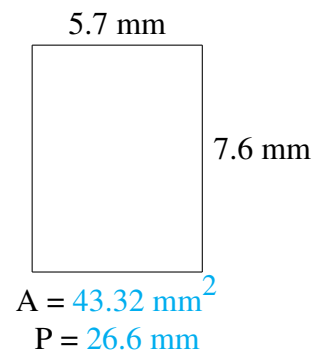
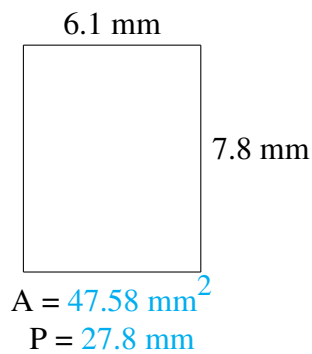
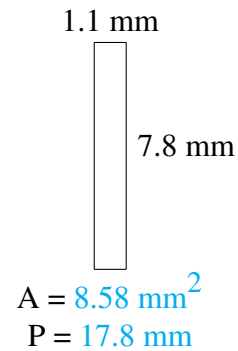
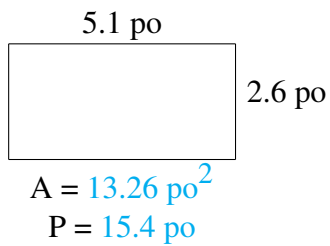

Aire et Périmètre de Rectangles (H)

Trouvez l'aire et le périmètre de chaque rectangle.

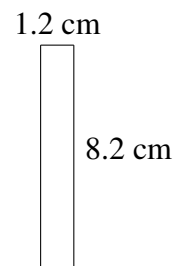
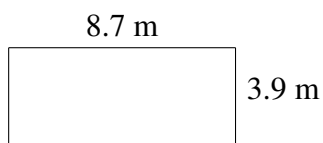
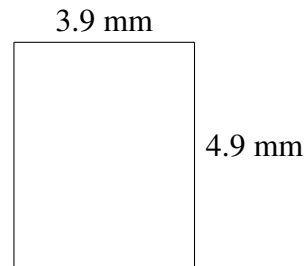
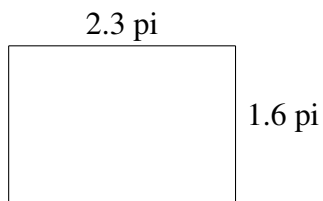
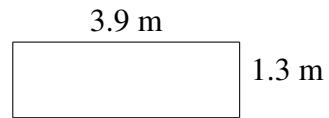
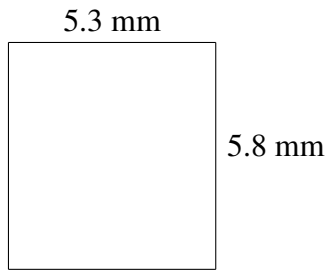

Aire et Périmètre de Rectangles (H) Solutions

Trouvez l'aire et le périmètre de chaque rectangle.

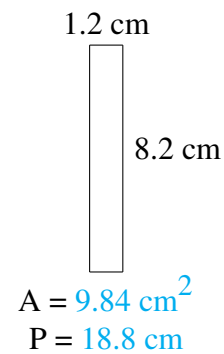
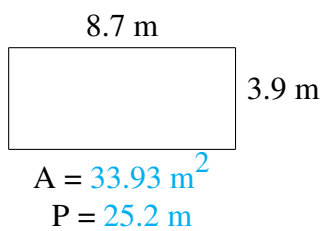
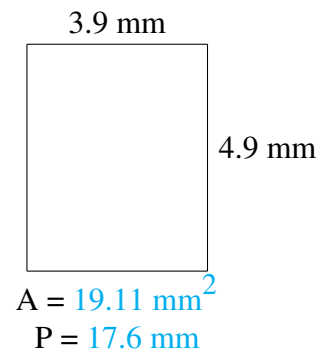
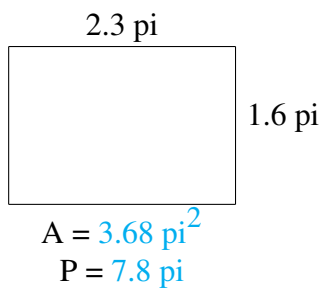
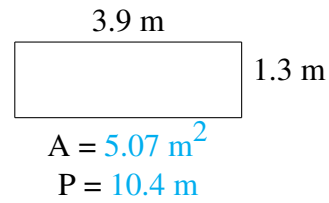
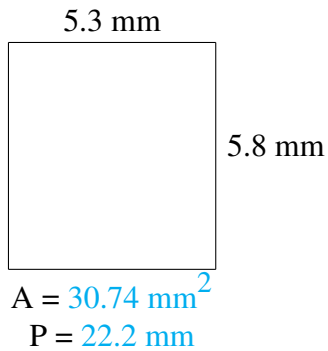

Aire et Périmètre de Rectangles (I)

Trouvez l'aire et le périmètre de chaque rectangle.

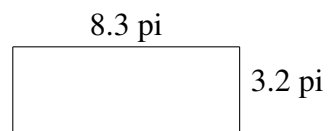
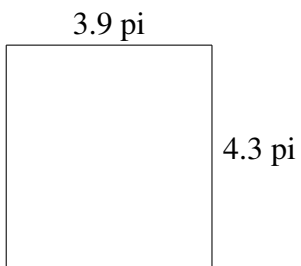
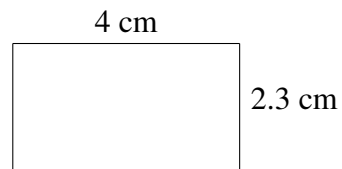
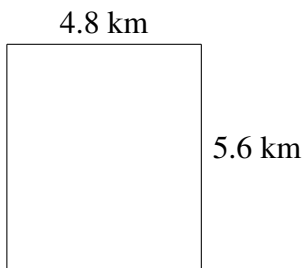
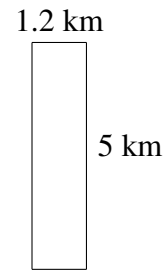
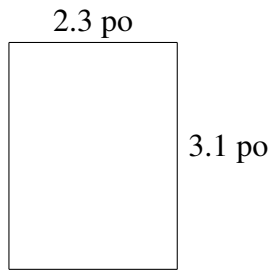

Aire et Périmètre de Rectangles (I) Solutions

Trouvez l'aire et le périmètre de chaque rectangle.

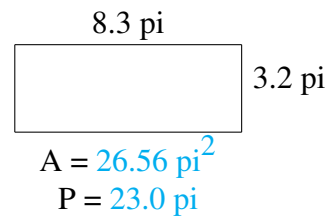
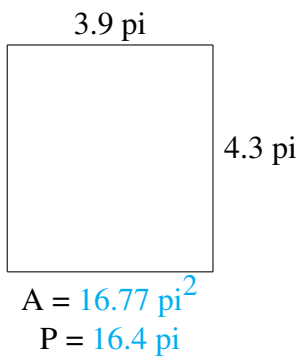
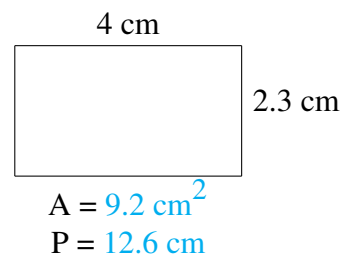
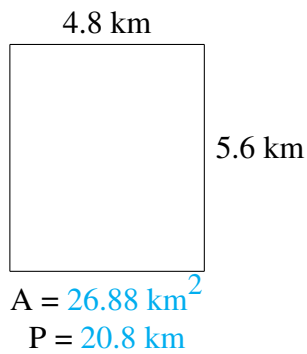
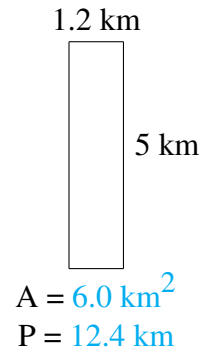
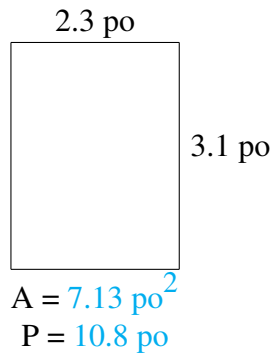

Aire et Périmètre de Rectangles (J)

Trouvez l'aire et le périmètre de chaque rectangle.

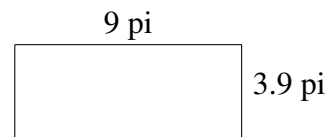
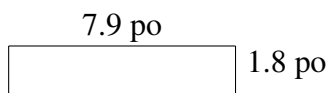
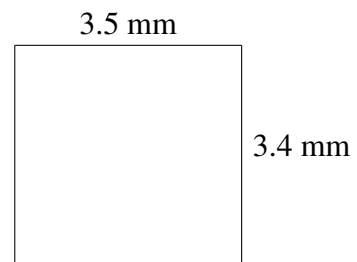
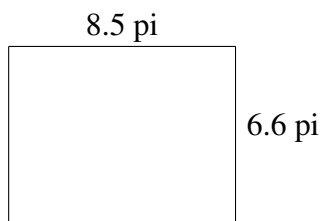
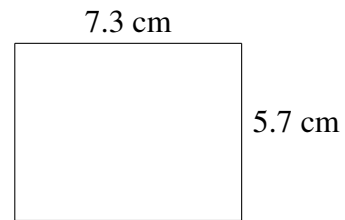
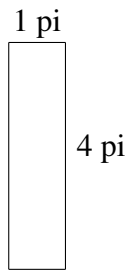

Aire et Périmètre de Rectangles (J) Solutions

Trouvez l'aire et le périmètre de chaque rectangle.

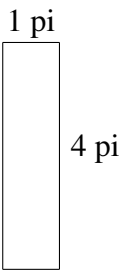

1 pi
 4 pi

$A = 4 \text{ pi}^2$
 $P = 10 \text{ pi}$

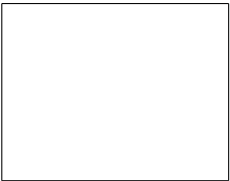

7.3 cm
 5.7 cm

$A = 41.61 \text{ cm}^2$
 $P = 26.0 \text{ cm}$

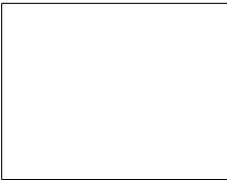

8.5 pi
 6.6 pi

$A = 56.10 \text{ pi}^2$
 $P = 30.2 \text{ pi}$

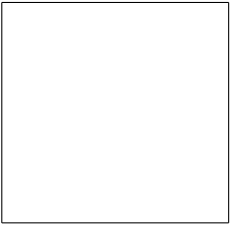

3.5 mm
 3.4 mm

$A = 11.90 \text{ mm}^2$
 $P = 13.8 \text{ mm}$



7.9 po
 1.8 po

$A = 14.22 \text{ po}^2$
 $P = 19.4 \text{ po}$



9 pi
 3.9 pi

$A = 35.1 \text{ pi}^2$
 $P = 25.8 \text{ pi}$