

# Rotations (A)

Dessinez l'image de la rotation décrite.

Rotation dans le sens horaire de  $90^\circ$  autour du point  $(0, 0)$ .

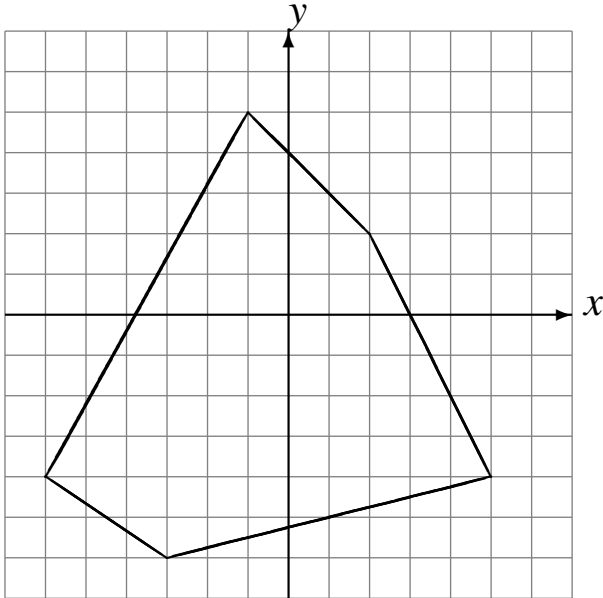

Rotation de  $180^\circ$  autour du point  $(0, 0)$ .

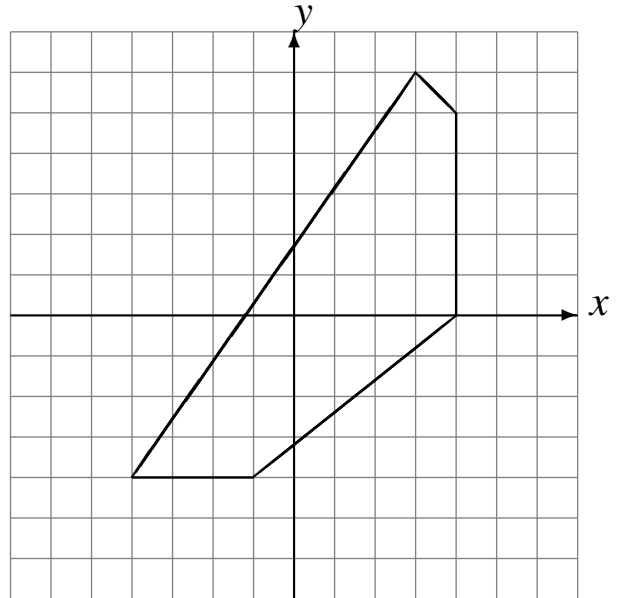

Rotation dans le sens horaire de  $90^\circ$  autour du point  $(0, 0)$ .

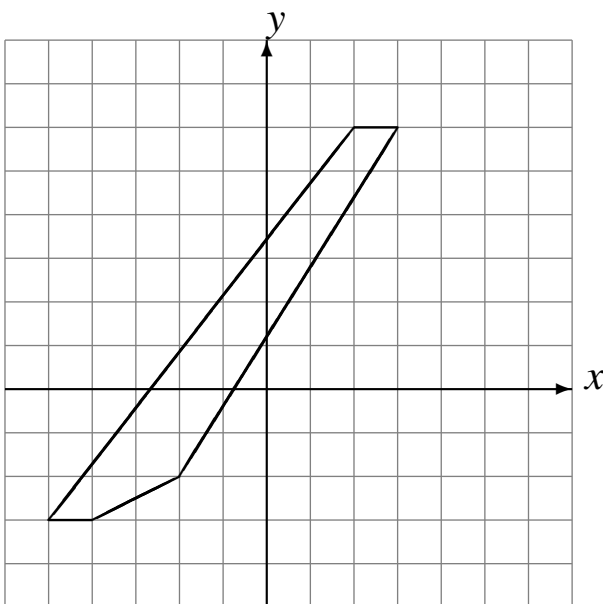

Rotation de  $180^\circ$  autour du point  $(0, 0)$ .

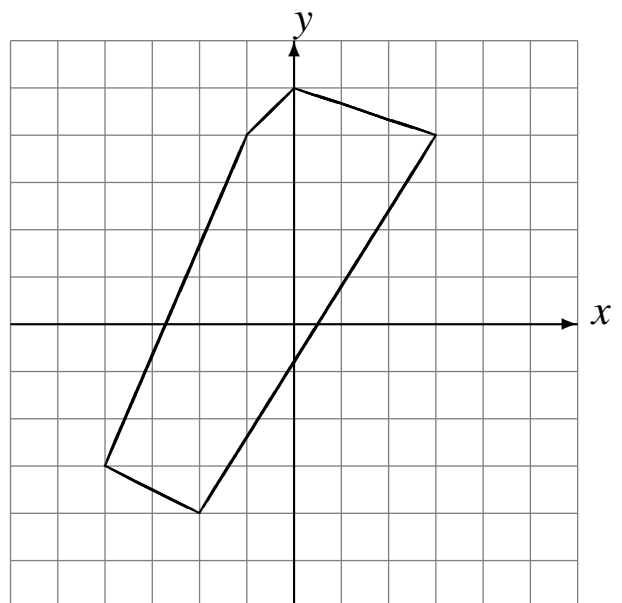

# Rotations (A) Solutions

Dessinez l'image de la rotation décrite.

Rotation dans le sens horaire de  $90^\circ$  autour du point  $(0, 0)$ .

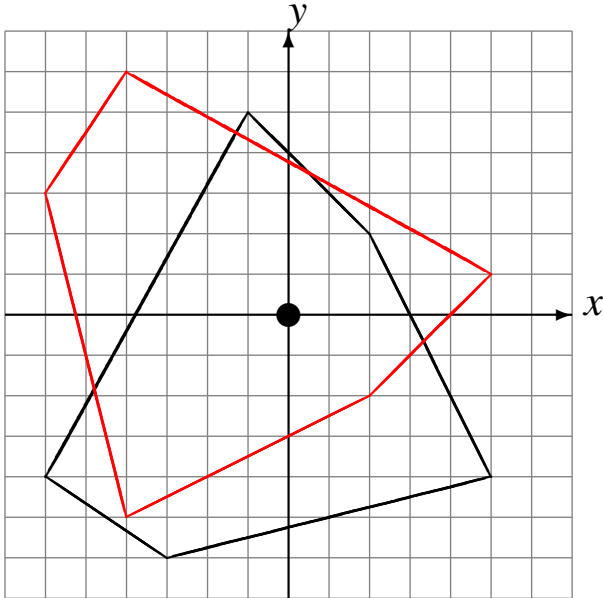

Rotation de  $180^\circ$  autour du point  $(0, 0)$ .

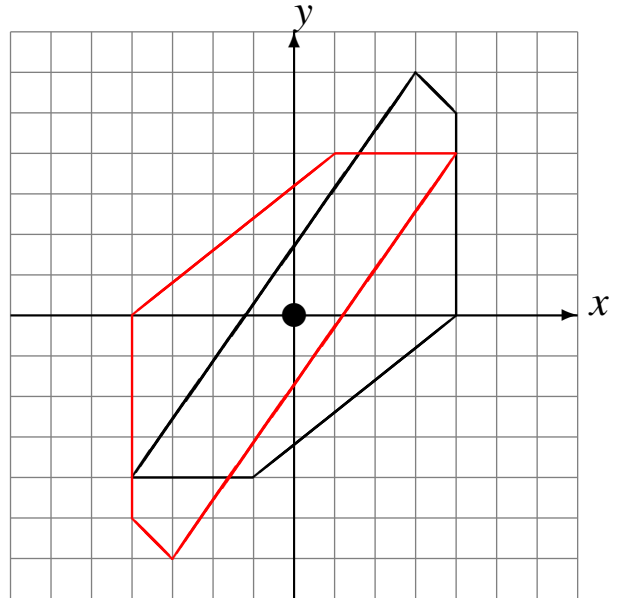

Rotation dans le sens horaire de  $90^\circ$  autour du point  $(0, 0)$ .

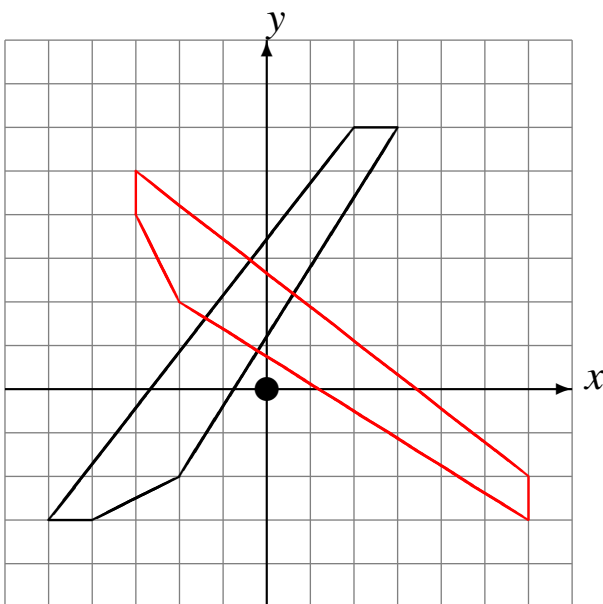

Rotation de  $180^\circ$  autour du point  $(0, 0)$ .

