

L'Homothétie (A)

Dessinez l'image de l'homothétie décrite.

Homothétie de centre $(0, 0)$ et de rapport $\frac{1}{4}$.

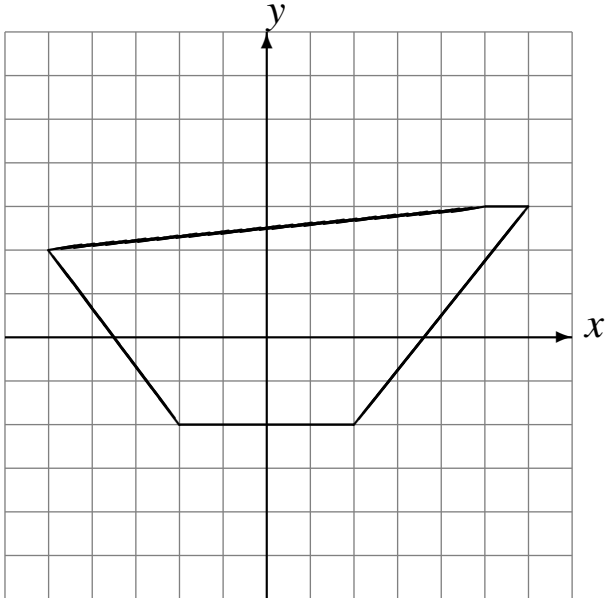

Homothétie de centre $(0, 0)$ et de rapport $\frac{1}{4}$.

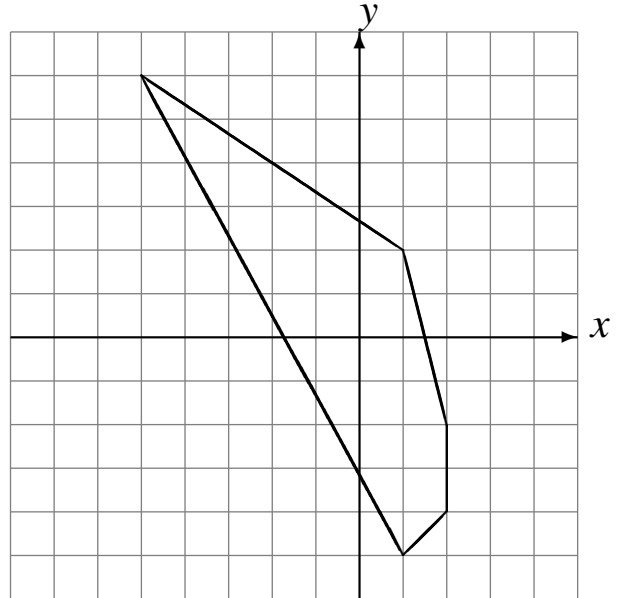

Homothétie de centre $(0, 0)$ et de rapport 3.

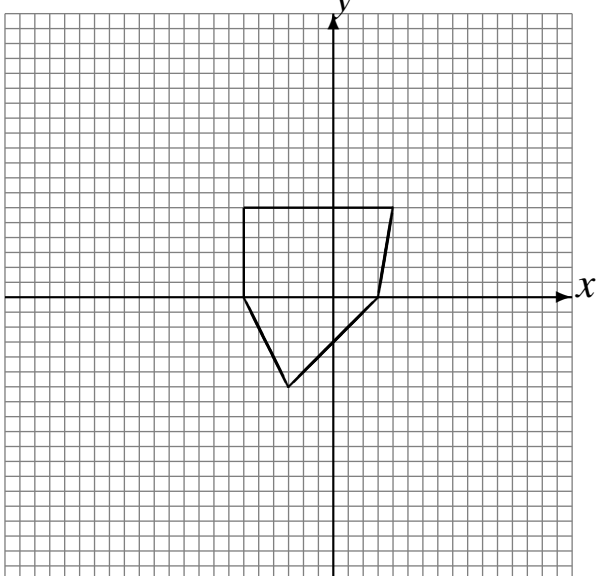

Homothétie de centre $(0, 0)$ et de rapport $\frac{1}{3}$.

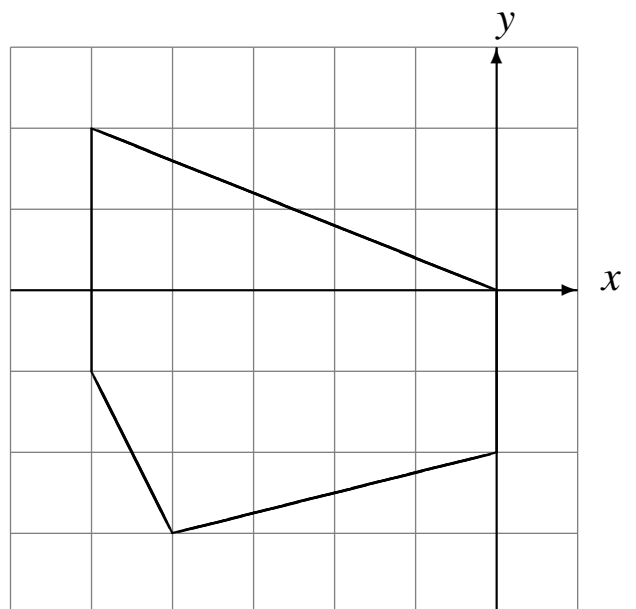

L'Homothétie (A) Solutions

Dessinez l'image de l'homothétie décrite.

Homothétie de centre $(0, 0)$ et de rapport $\frac{1}{4}$.

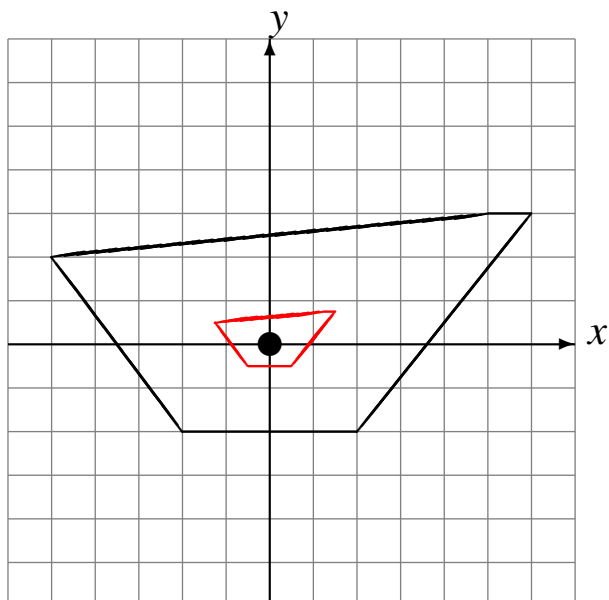

Homothétie de centre $(0, 0)$ et de rapport $\frac{1}{4}$.

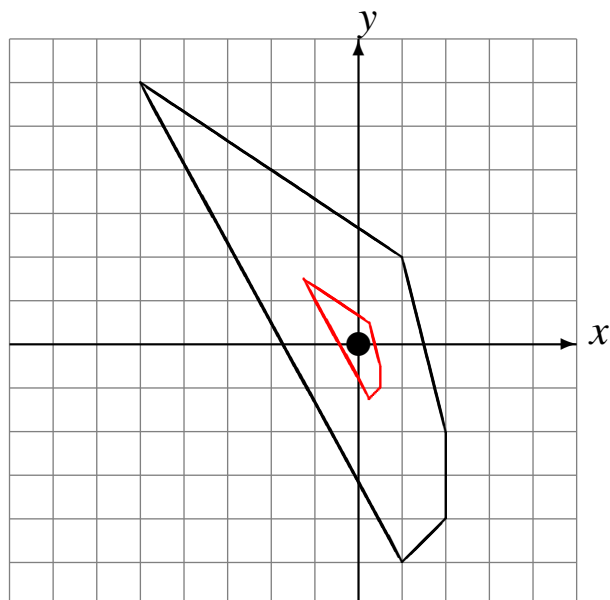

Homothétie de centre $(0, 0)$ et de rapport 3.

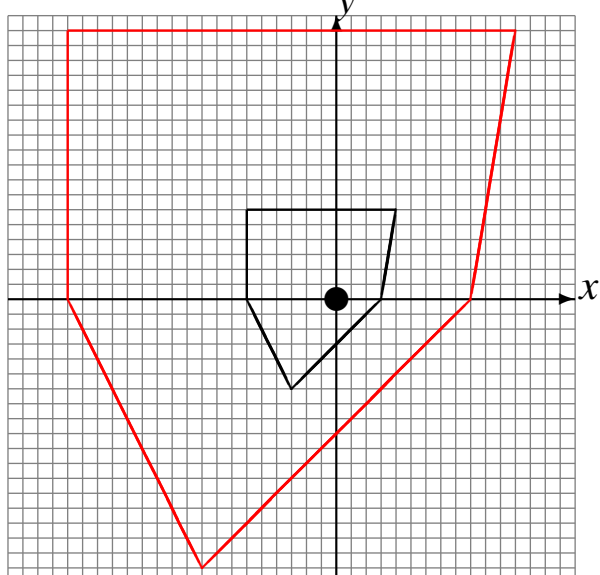

Homothétie de centre $(0, 0)$ et de rapport $\frac{1}{3}$.

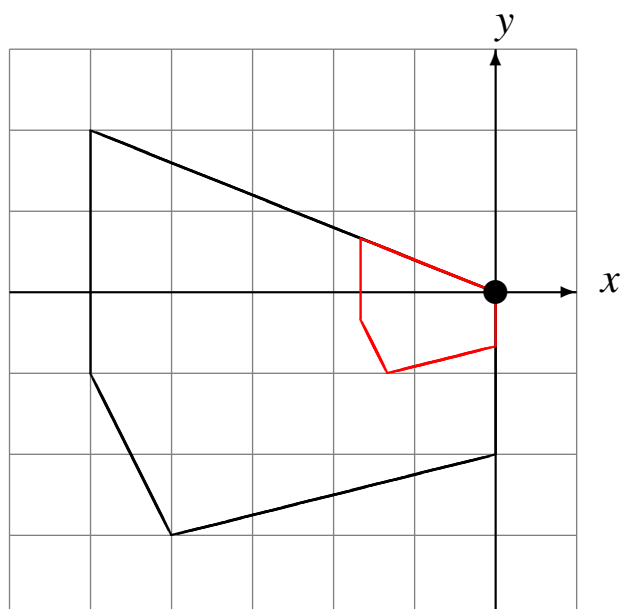

L'Homothétie (B)

Dessinez l'image de l'homothétie décrite.

Homothétie de centre $(0, 0)$ et de rapport $\frac{1}{3}$.

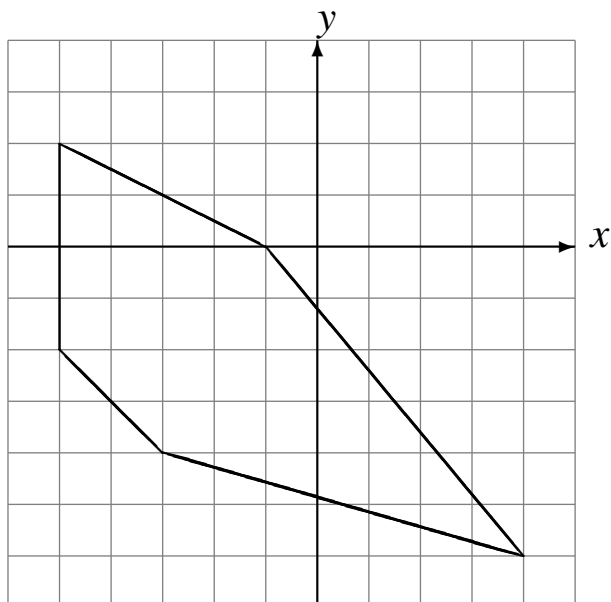

Homothétie de centre $(0, 0)$ et de rapport $\frac{1}{2}$.

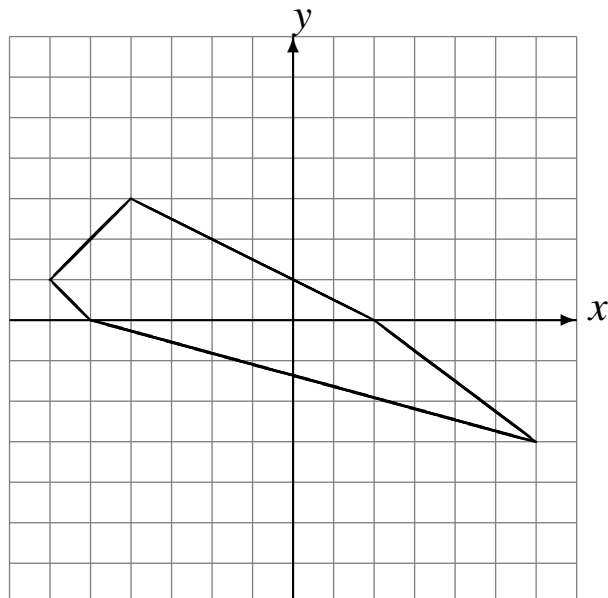

Homothétie de centre $(0, 0)$ et de rapport 4.

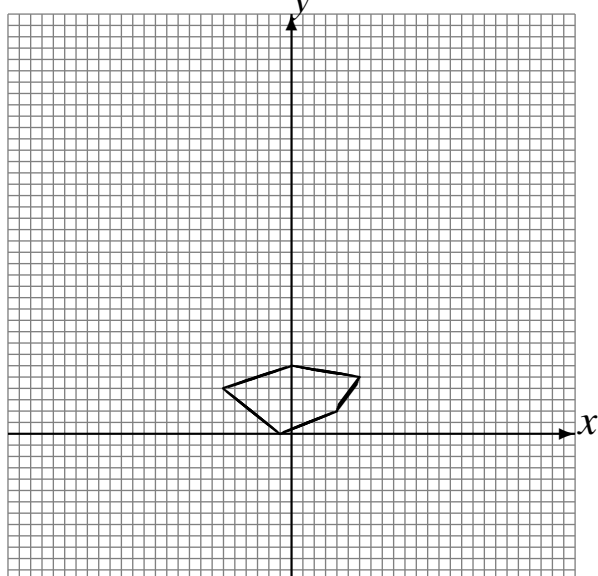

Homothétie de centre $(0, 0)$ et de rapport $\frac{1}{2}$.

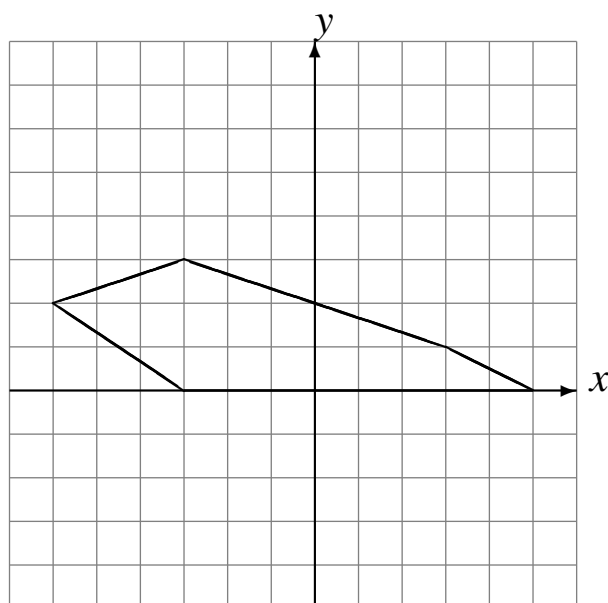

L'Homothétie (B) Solutions

Dessinez l'image de l'homothétie décrite.

Homothétie de centre $(0, 0)$ et de rapport $\frac{1}{3}$.

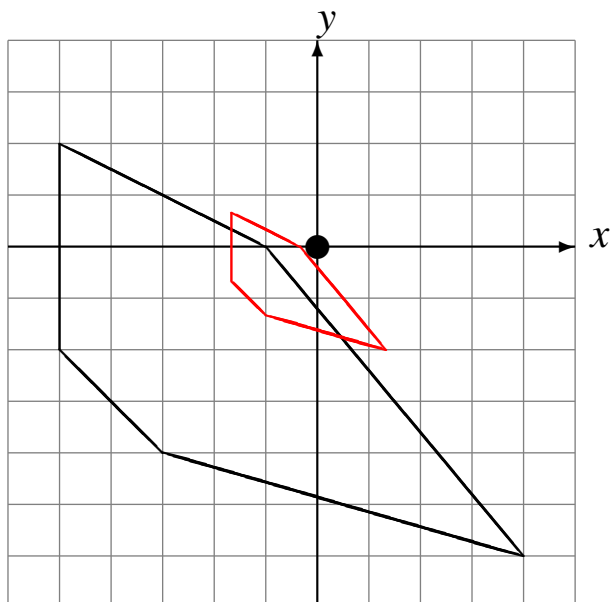

Homothétie de centre $(0, 0)$ et de rapport $\frac{1}{2}$.

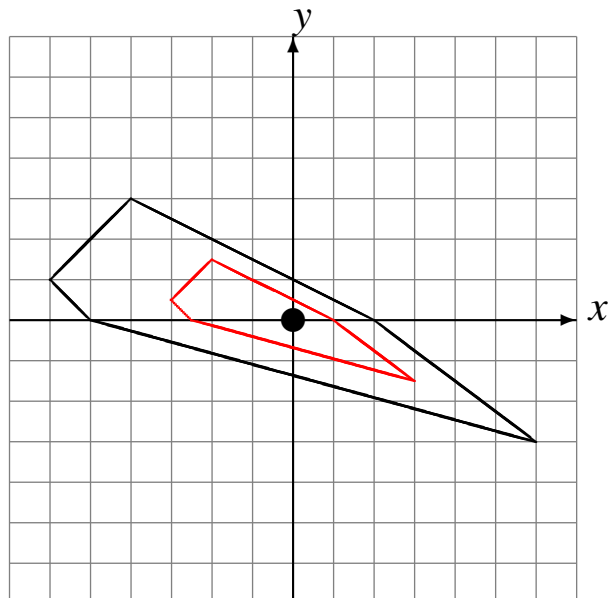

Homothétie de centre $(0, 0)$ et de rapport 4.

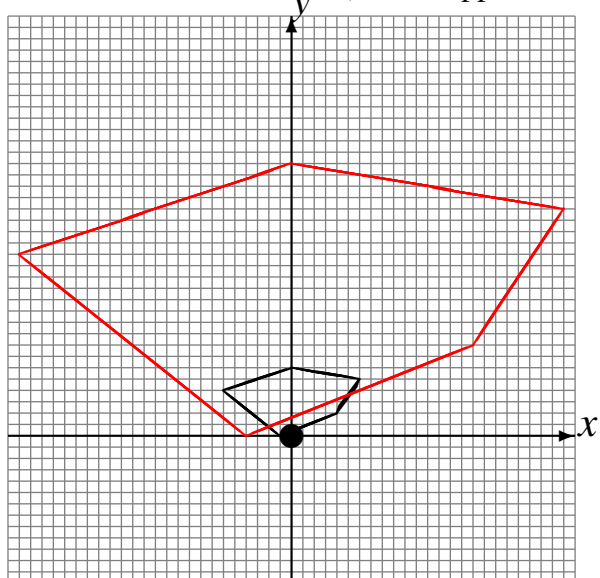

Homothétie de centre $(0, 0)$ et de rapport $\frac{1}{2}$.

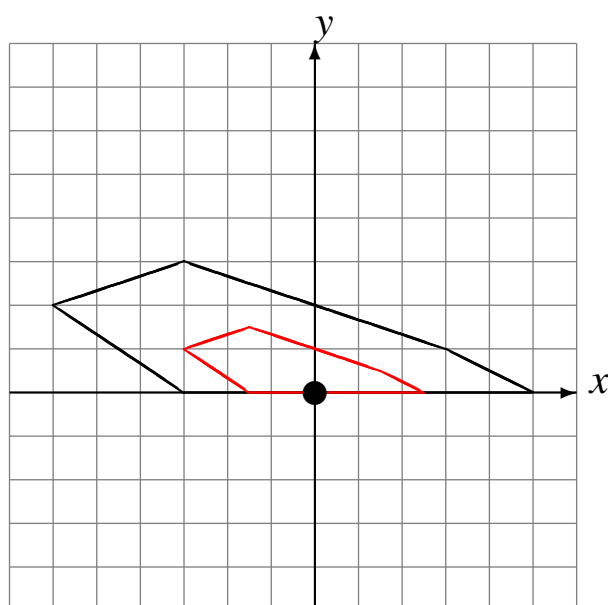

L'Homothétie (C)

Dessinez l'image de l'homothétie décrite.

Homothétie de centre $(0, 0)$ et de rapport 4.

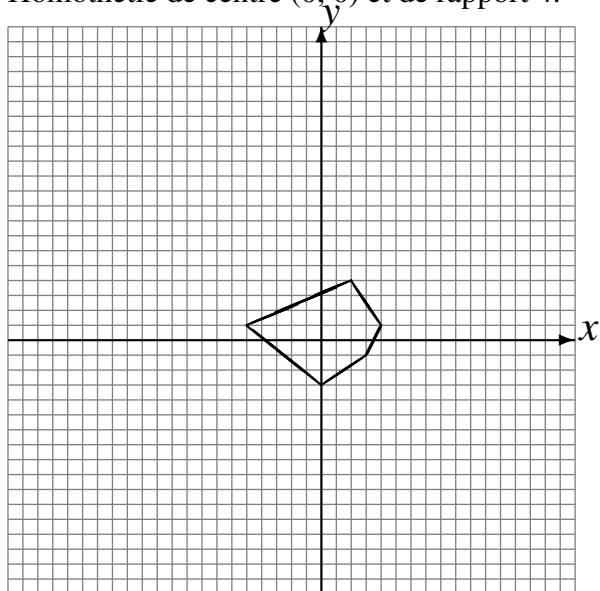

Homothétie de centre $(0, 0)$ et de rapport $\frac{1}{2}$.

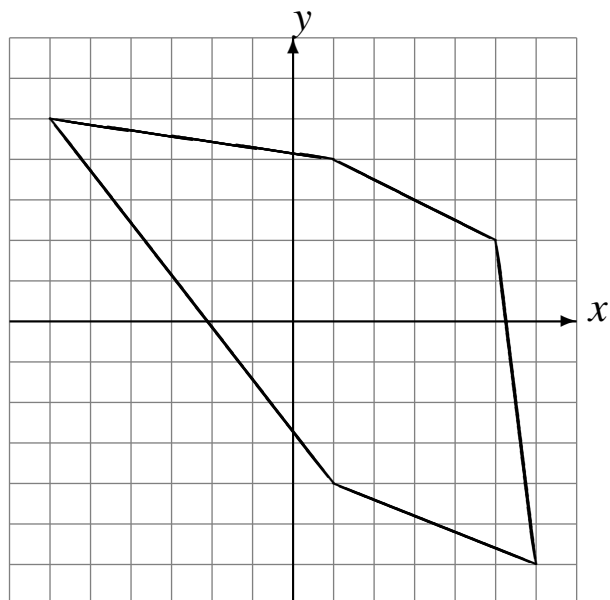

Homothétie de centre $(0, 0)$ et de rapport 2.

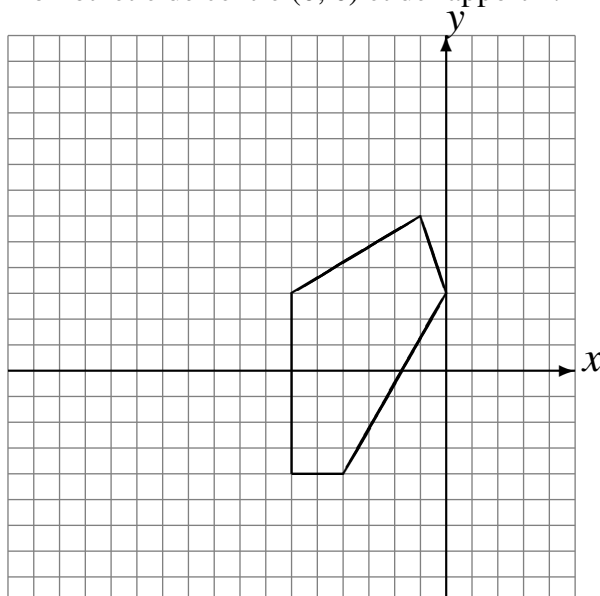

Homothétie de centre $(0, 0)$ et de rapport $\frac{1}{4}$.

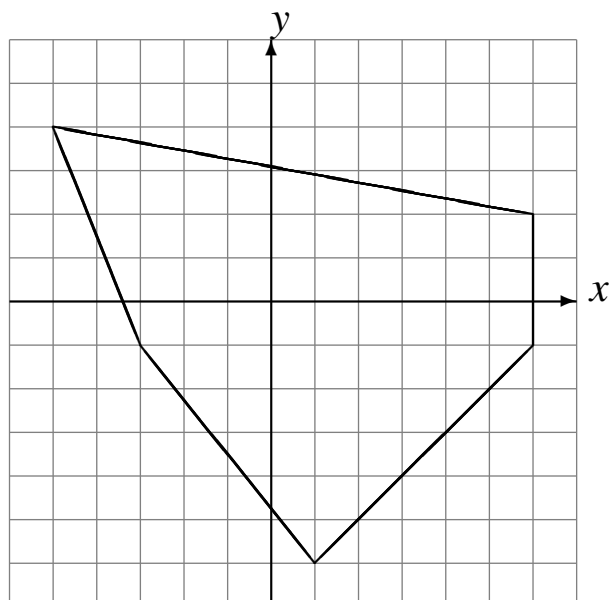

L'Homothétie (C) Solutions

Dessinez l'image de l'homothétie décrite.

Homothétie de centre $(0, 0)$ et de rapport 4.

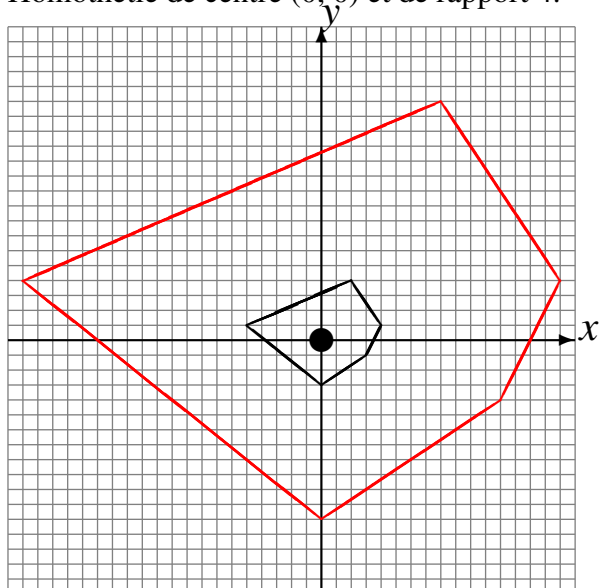

Homothétie de centre $(0, 0)$ et de rapport $\frac{1}{2}$.

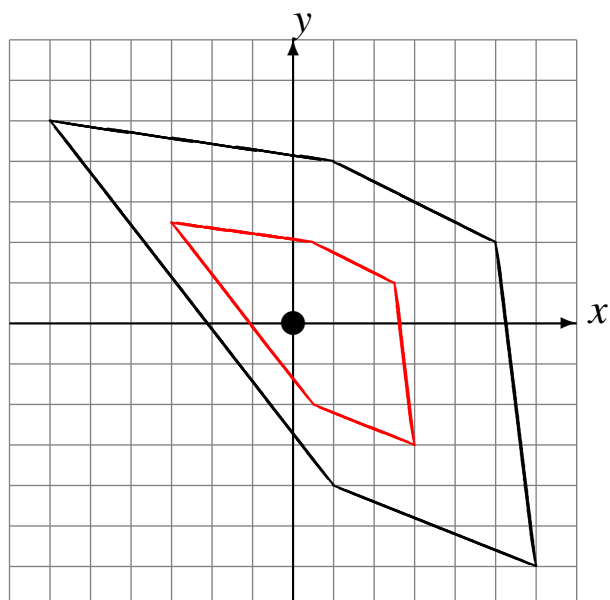

Homothétie de centre $(0, 0)$ et de rapport 2.

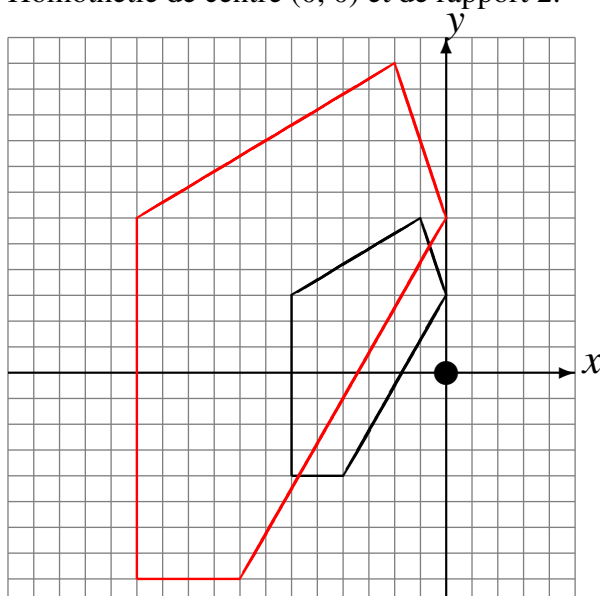

Homothétie de centre $(0, 0)$ et de rapport $\frac{1}{4}$.

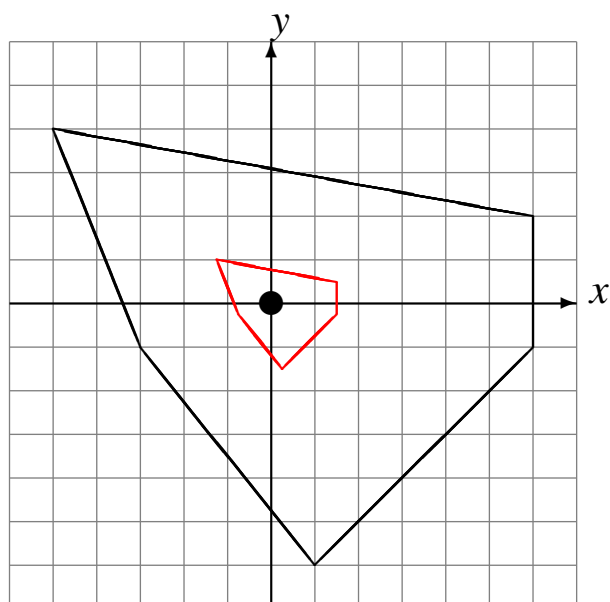

L'Homothétie (D)

Dessinez l'image de l'homothétie décrite.

Homothétie de centre $(0, 0)$ et de rapport 2.

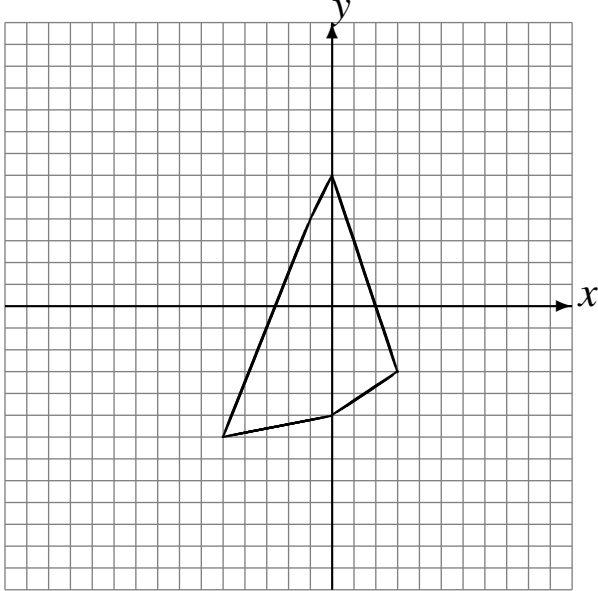

Homothétie de centre $(0, 0)$ et de rapport $\frac{1}{4}$.

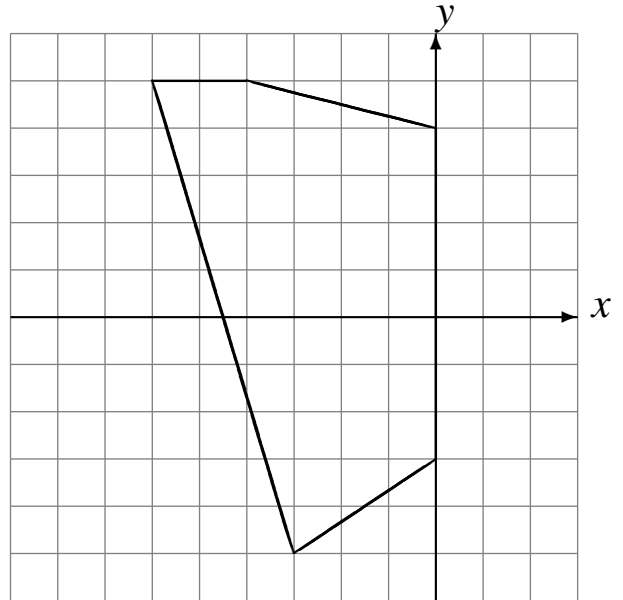

Homothétie de centre $(0, 0)$ et de rapport $\frac{1}{3}$.

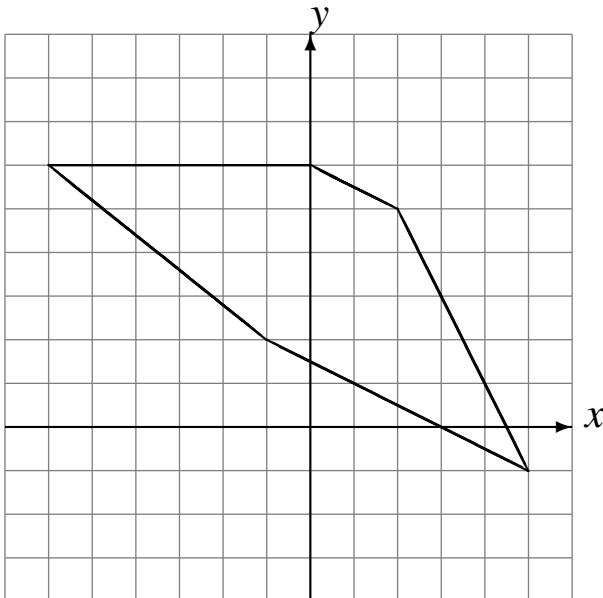

Homothétie de centre $(0, 0)$ et de rapport $\frac{1}{4}$.

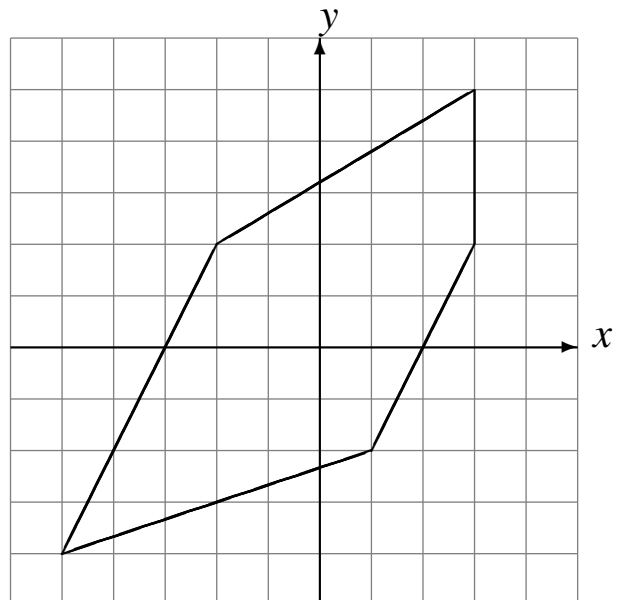

L'Homothétie (D) Solutions

Dessinez l'image de l'homothétie décrite.

Homothétie de centre $(0, 0)$ et de rapport 2.

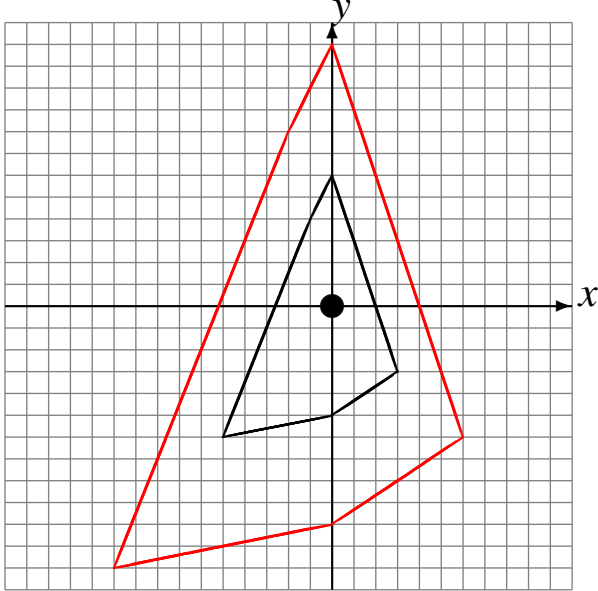

Homothétie de centre $(0, 0)$ et de rapport $\frac{1}{4}$.

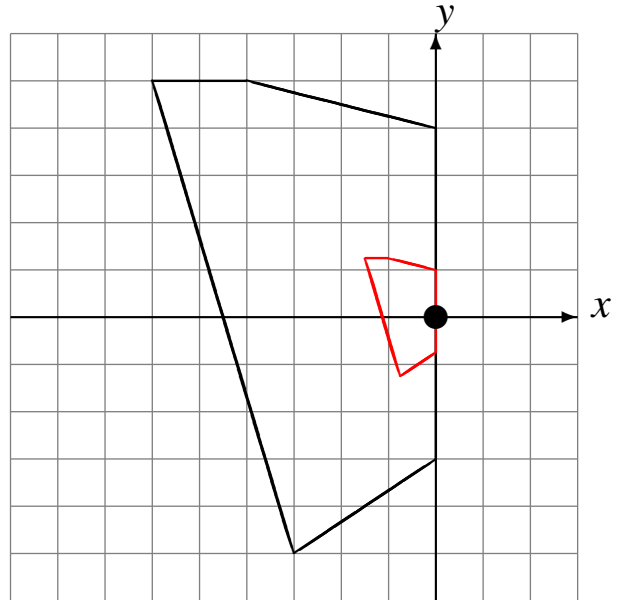

Homothétie de centre $(0, 0)$ et de rapport $\frac{1}{3}$.

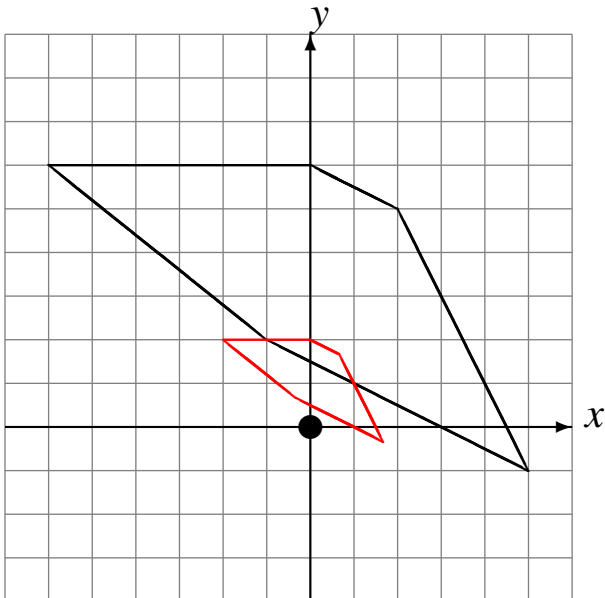

Homothétie de centre $(0, 0)$ et de rapport $\frac{1}{4}$.

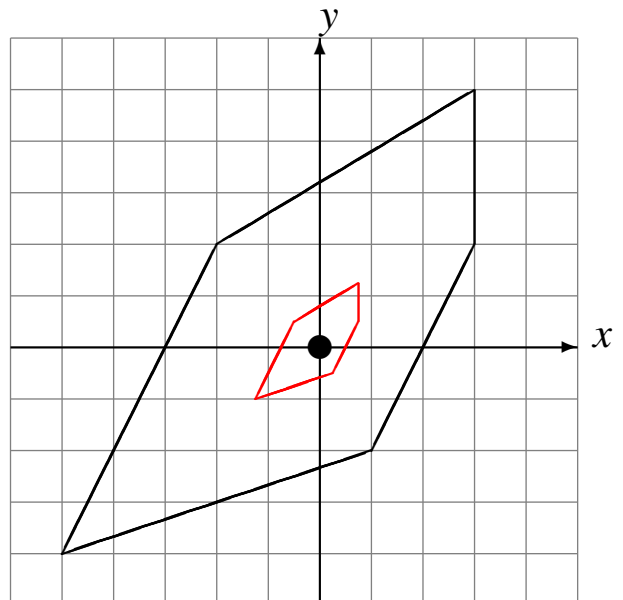

L'Homothétie (E)

Dessinez l'image de l'homothétie décrite.

Homothétie de centre $(0, 0)$ et de rapport $\frac{1}{2}$.

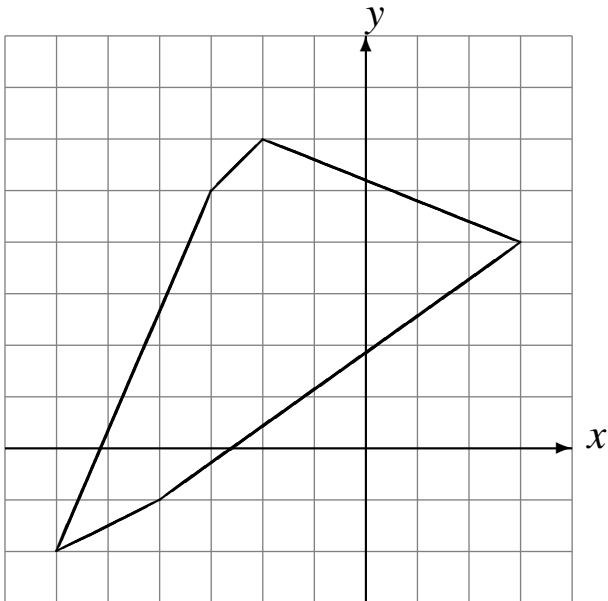

Homothétie de centre $(0, 0)$ et de rapport 4.

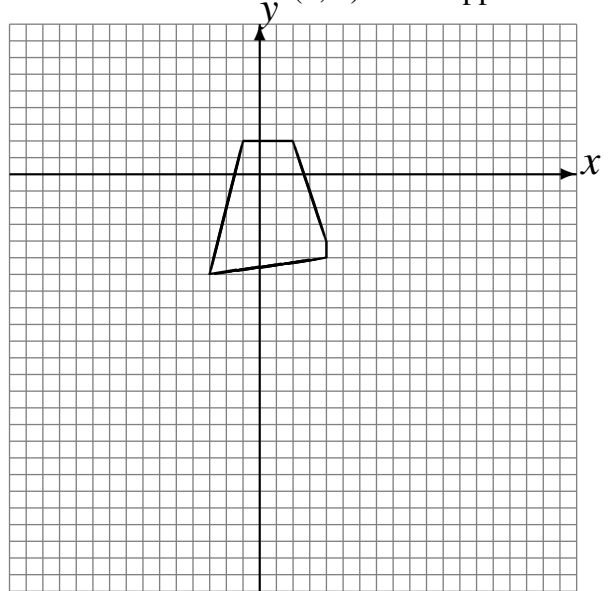

Homothétie de centre $(0, 0)$ et de rapport $\frac{1}{3}$.

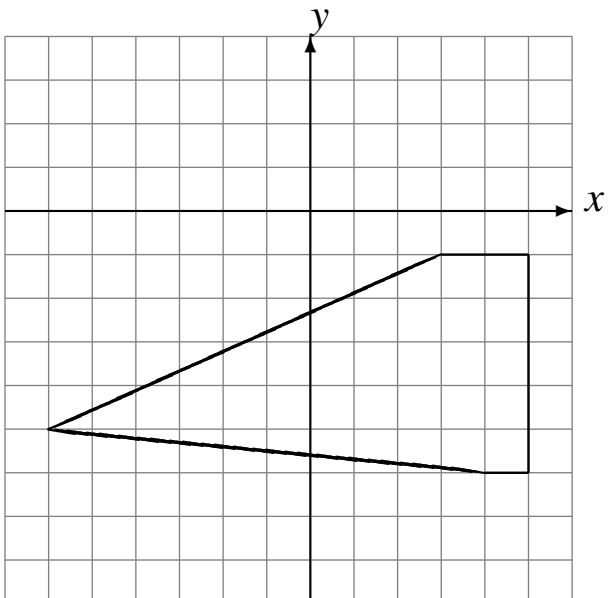

Homothétie de centre $(0, 0)$ et de rapport 4.

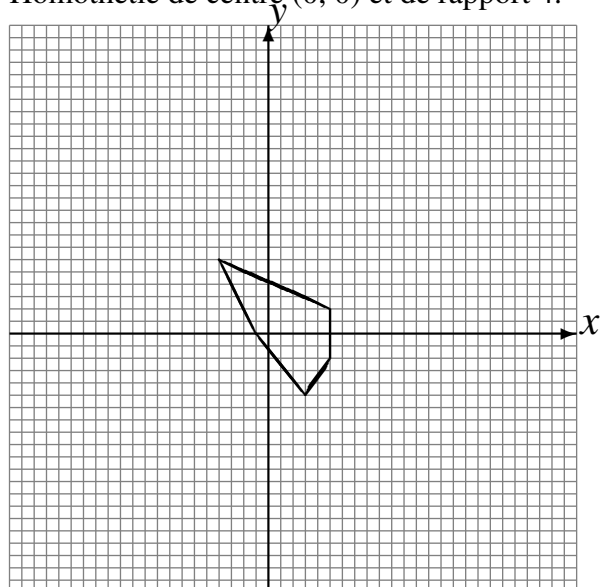

L'Homothétie (E) Solutions

Dessinez l'image de l'homothétie décrite.

Homothétie de centre $(0, 0)$ et de rapport $\frac{1}{2}$.

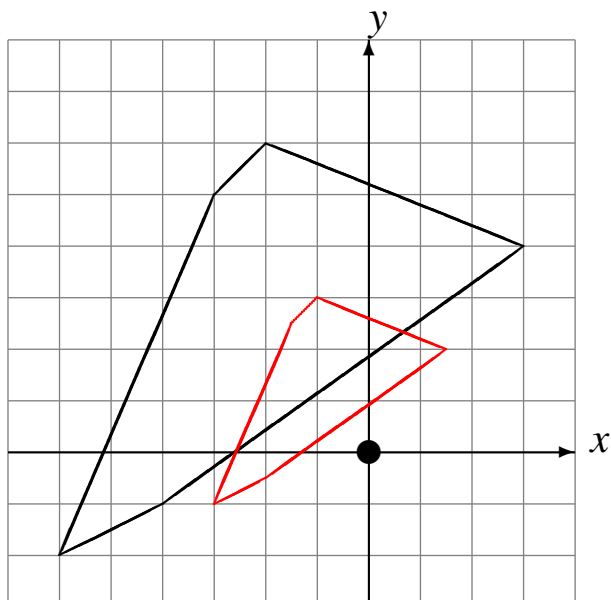

Homothétie de centre $(0, 0)$ et de rapport 4.

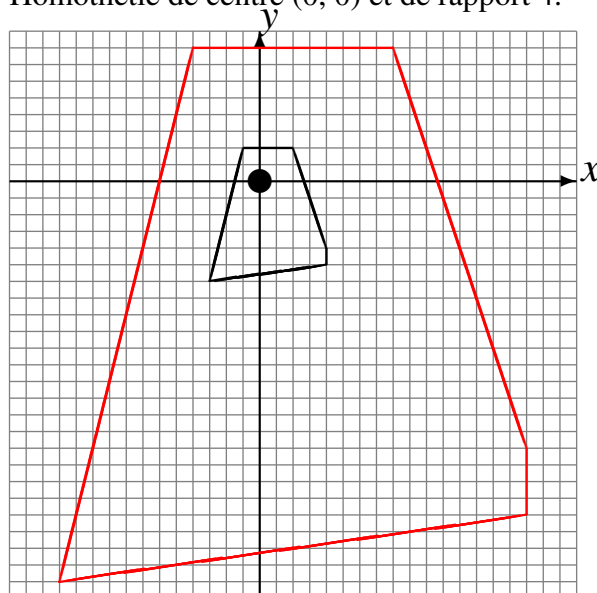

Homothétie de centre $(0, 0)$ et de rapport $\frac{1}{3}$.

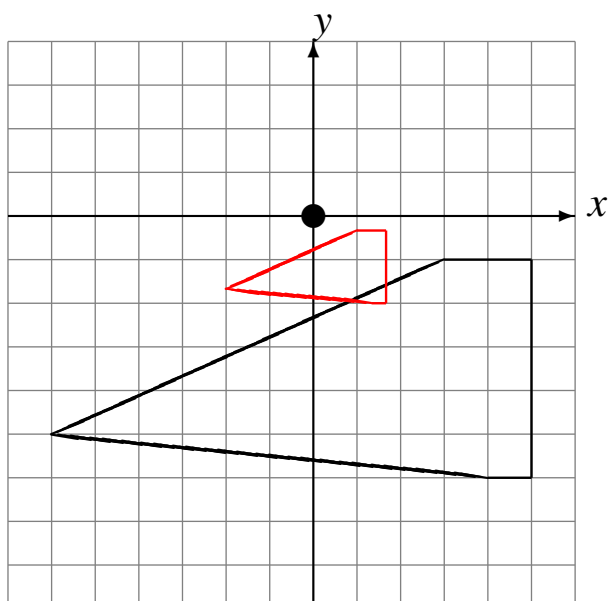

Homothétie de centre $(0, 0)$ et de rapport 4.

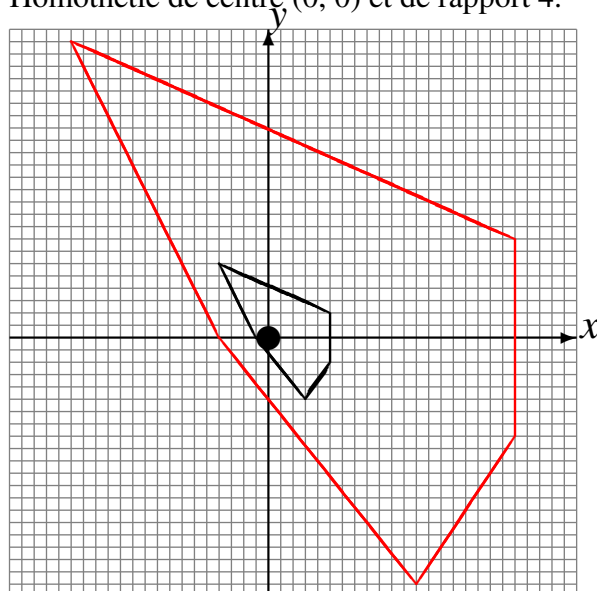

L'Homothétie (F)

Dessinez l'image de l'homothétie décrite.

Homothétie de centre $(0, 0)$ et de rapport 4.

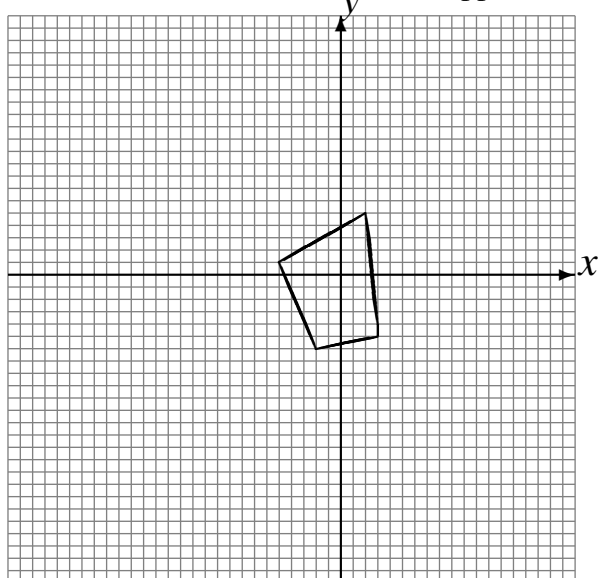

Homothétie de centre $(0, 0)$ et de rapport 2.

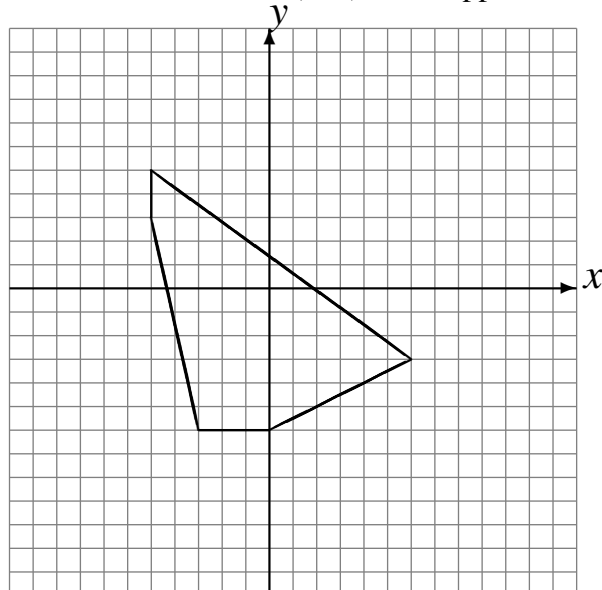

Homothétie de centre $(0, 0)$ et de rapport $\frac{1}{3}$.

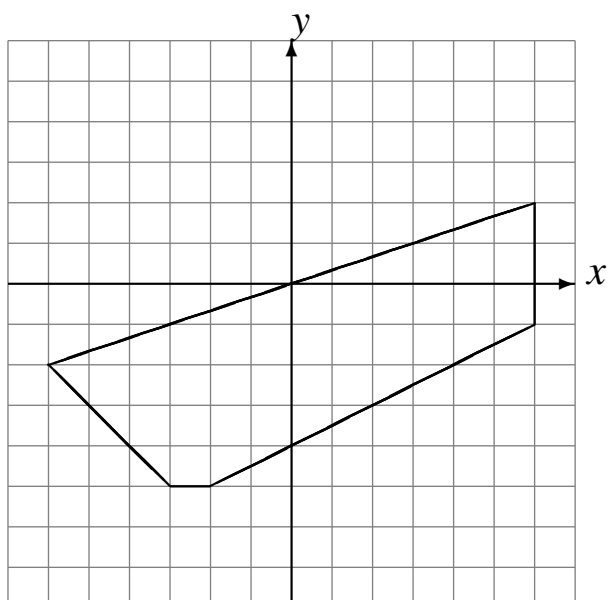

Homothétie de centre $(0, 0)$ et de rapport 2.

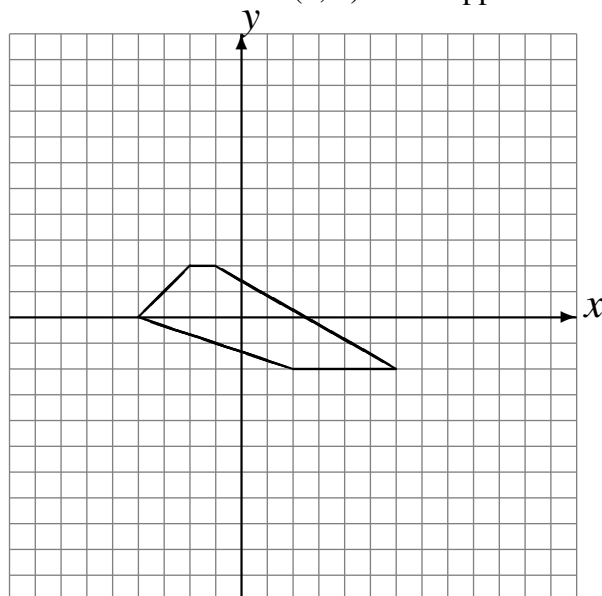

L'Homothétie (F) Solutions

Dessinez l'image de l'homothétie décrite.

Homothétie de centre $(0, 0)$ et de rapport 4.

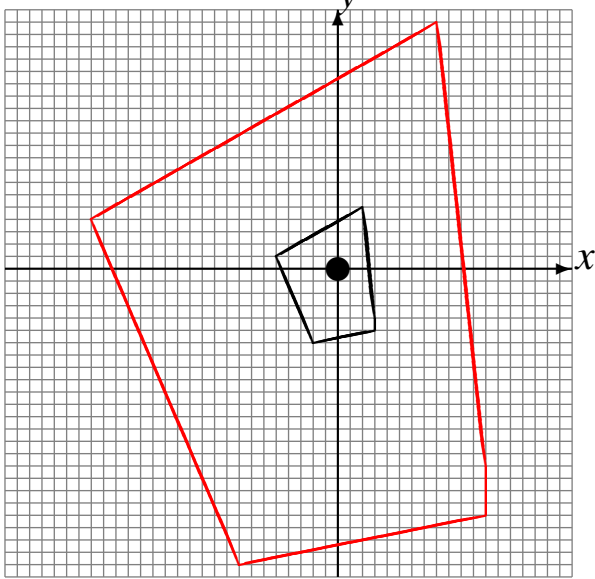

Homothétie de centre $(0, 0)$ et de rapport 2.

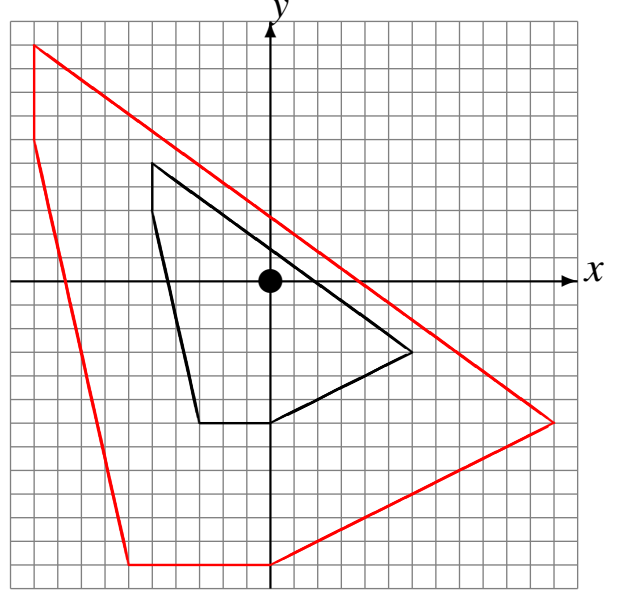

Homothétie de centre $(0, 0)$ et de rapport $\frac{1}{3}$.

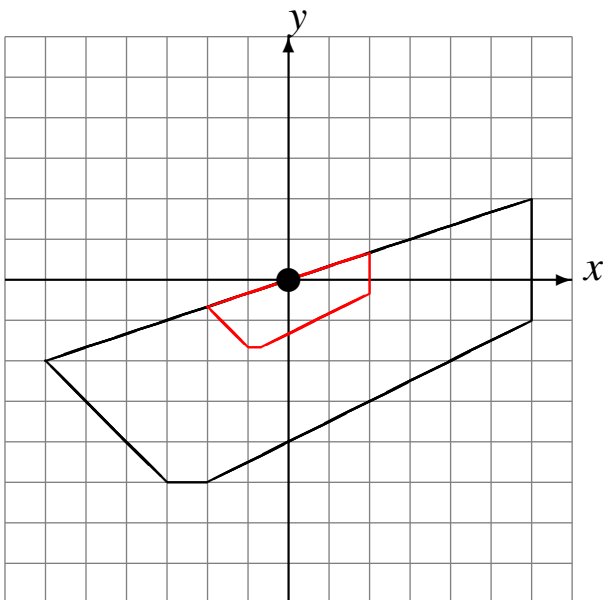

Homothétie de centre $(0, 0)$ et de rapport 2.

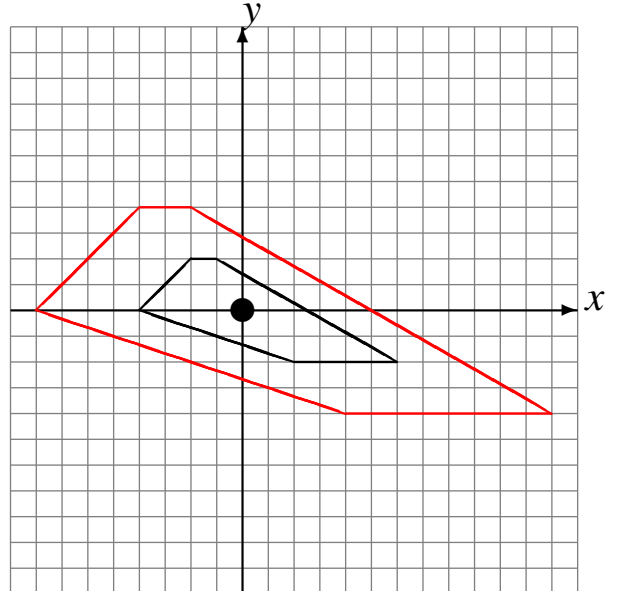

L'Homothétie (G)

Dessinez l'image de l'homothétie décrite.

Homothétie de centre $(0, 0)$ et de rapport 4.

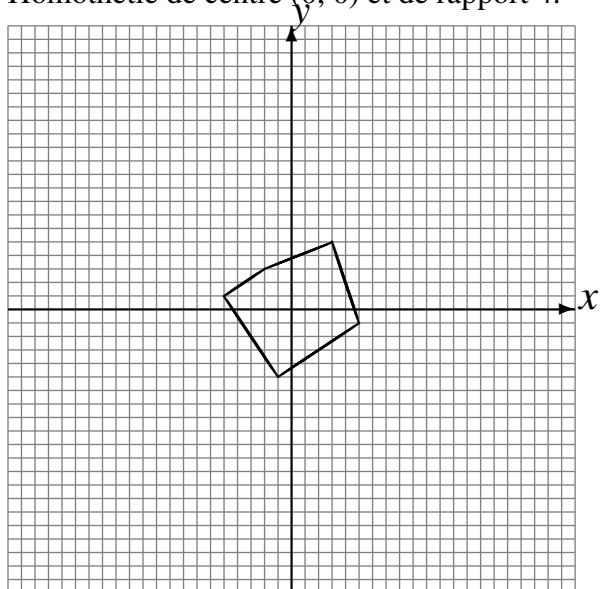

Homothétie de centre $(0, 0)$ et de rapport $\frac{1}{3}$.

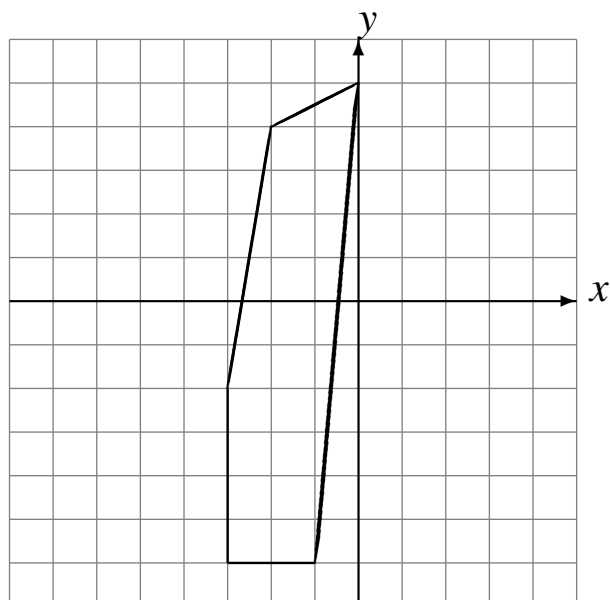

Homothétie de centre $(0, 0)$ et de rapport $\frac{1}{4}$.

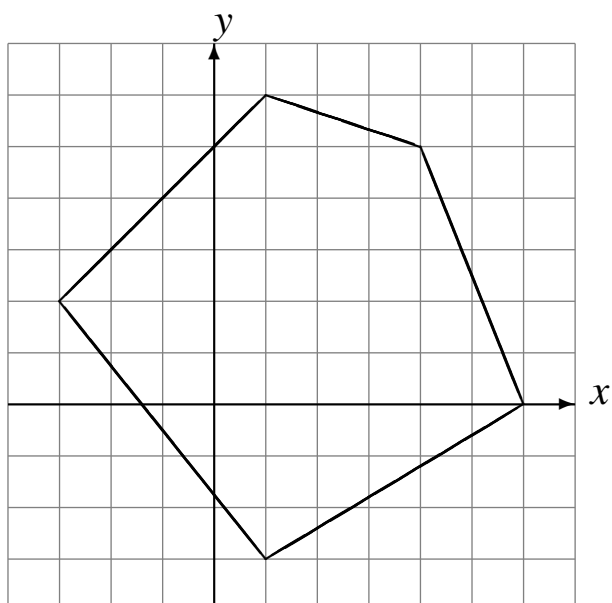

Homothétie de centre $(0, 0)$ et de rapport 3.

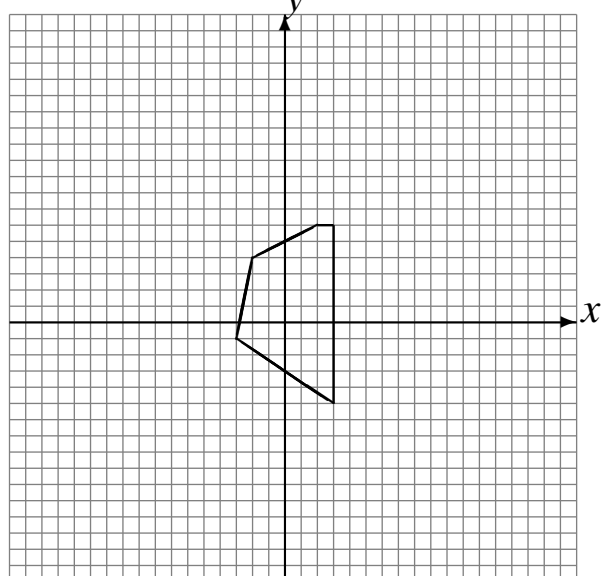

L'Homothétie (G) Solutions

Dessinez l'image de l'homothétie décrite.

Homothétie de centre $(0, 0)$ et de rapport 4.

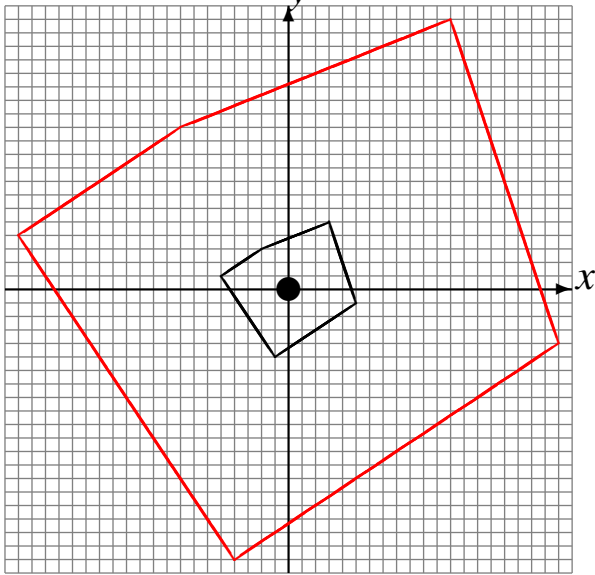

Homothétie de centre $(0, 0)$ et de rapport $\frac{1}{3}$.

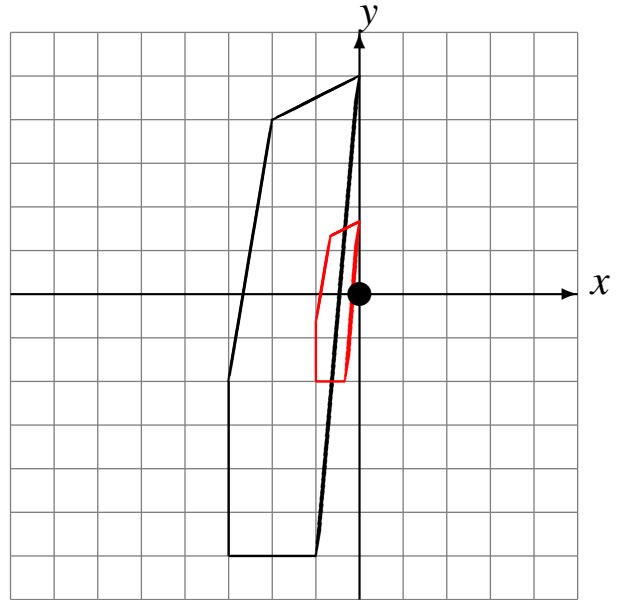

Homothétie de centre $(0, 0)$ et de rapport $\frac{1}{4}$.

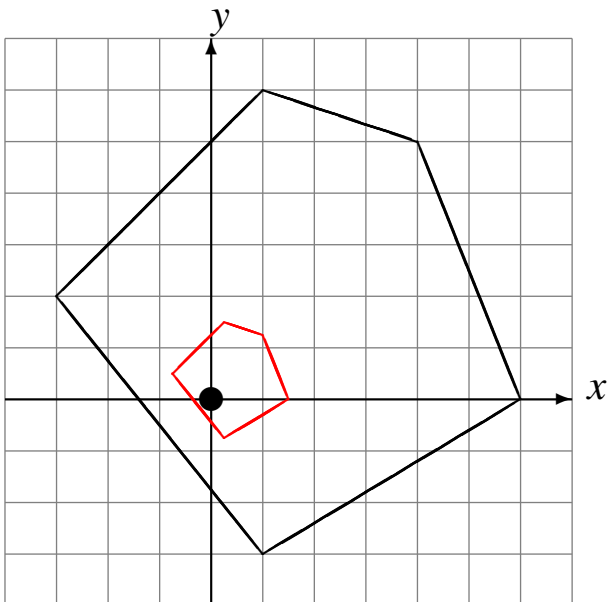

Homothétie de centre $(0, 0)$ et de rapport 3.

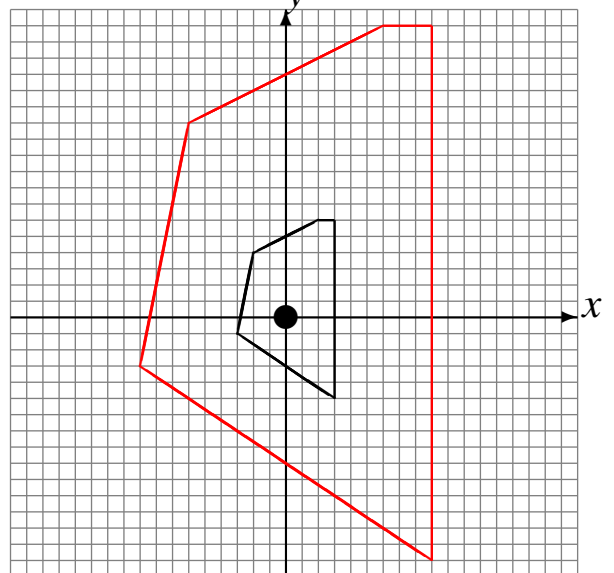

L'Homothétie (H)

Dessinez l'image de l'homothétie décrite.

Homothétie de centre $(0, 0)$ et de rapport 4.

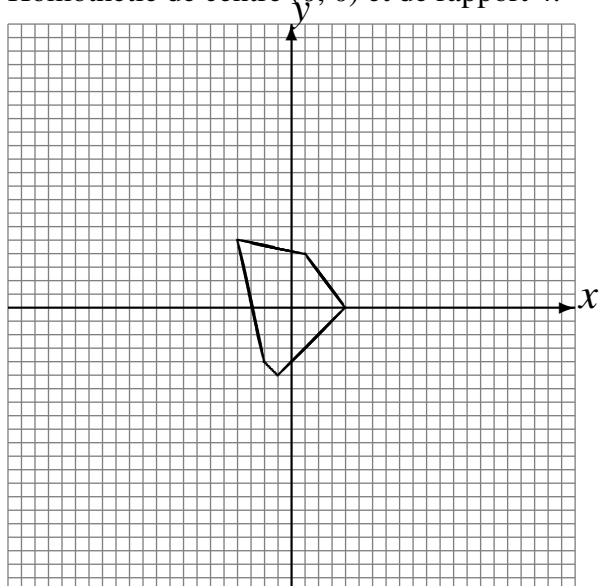

Homothétie de centre $(0, 0)$ et de rapport $\frac{1}{4}$.

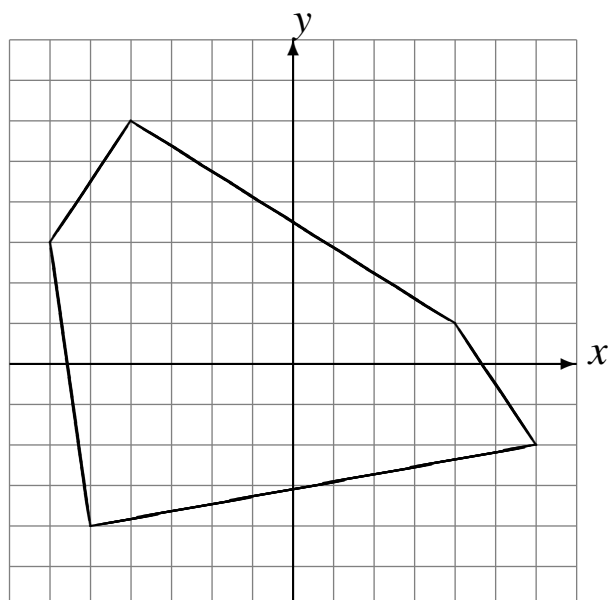

Homothétie de centre $(0, 0)$ et de rapport $\frac{1}{4}$.

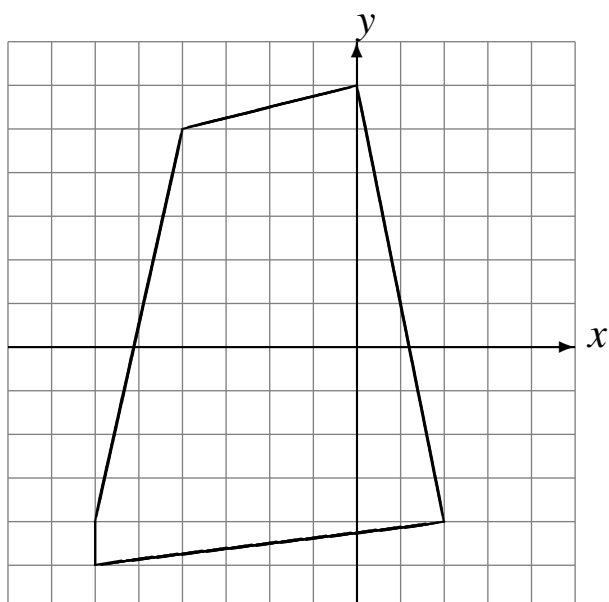

Homothétie de centre $(0, 0)$ et de rapport $\frac{1}{2}$.

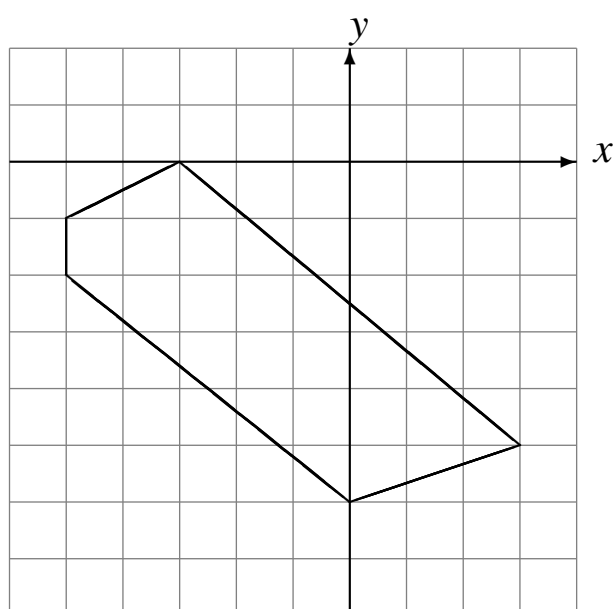

L'Homothétie (H) Solutions

Dessinez l'image de l'homothétie décrite.

Homothétie de centre $(0, 0)$ et de rapport 4.

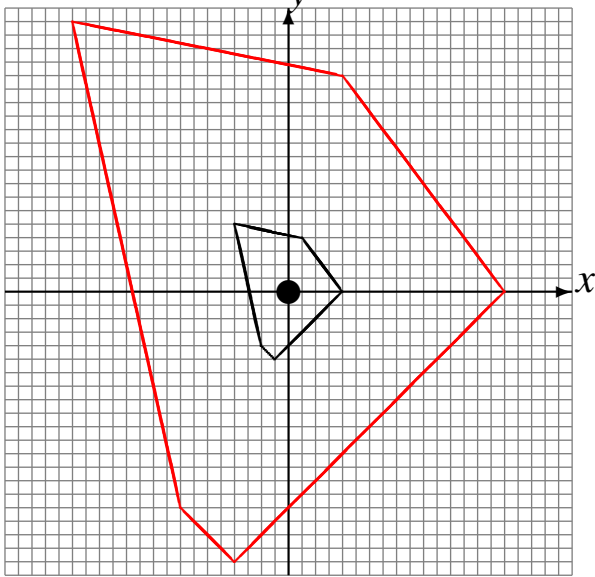

Homothétie de centre $(0, 0)$ et de rapport $\frac{1}{4}$.

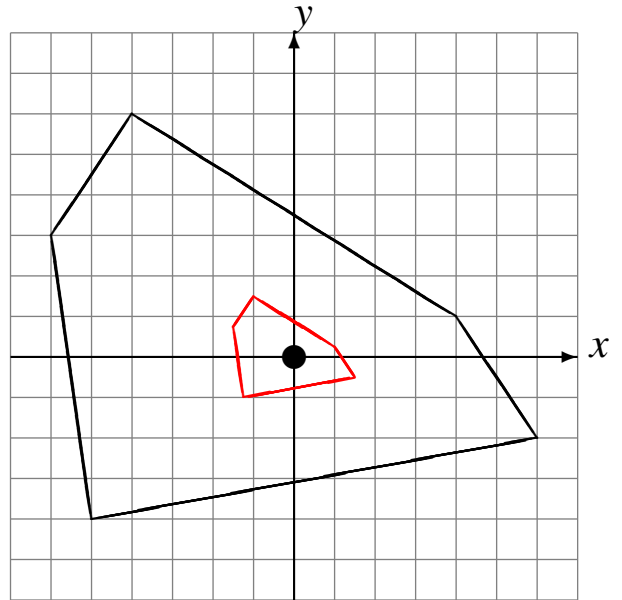

Homothétie de centre $(0, 0)$ et de rapport $\frac{1}{4}$.

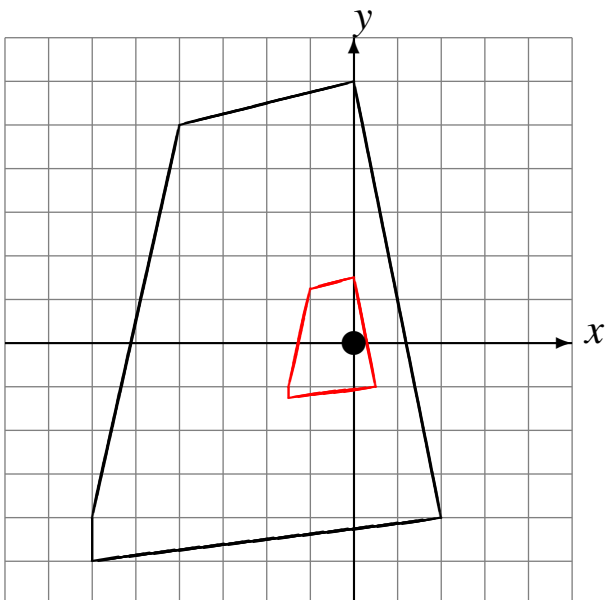

Homothétie de centre $(0, 0)$ et de rapport $\frac{1}{2}$.

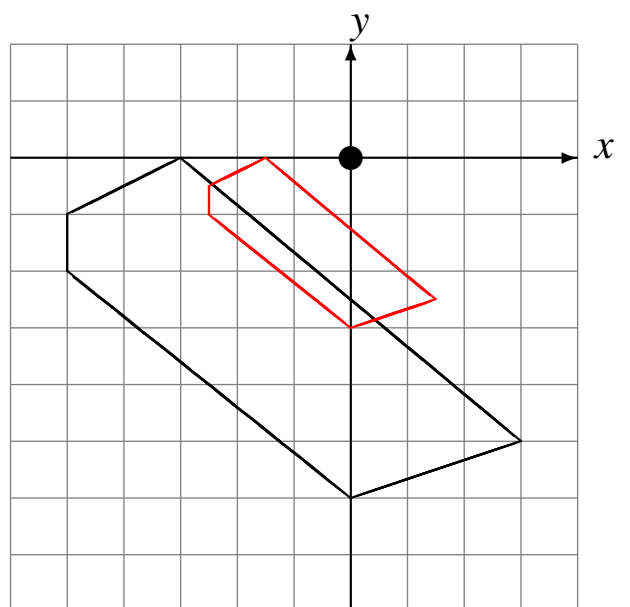

L'Homothétie (I)

Dessinez l'image de l'homothétie décrite.

Homothétie de centre $(0, 0)$ et de rapport 3.

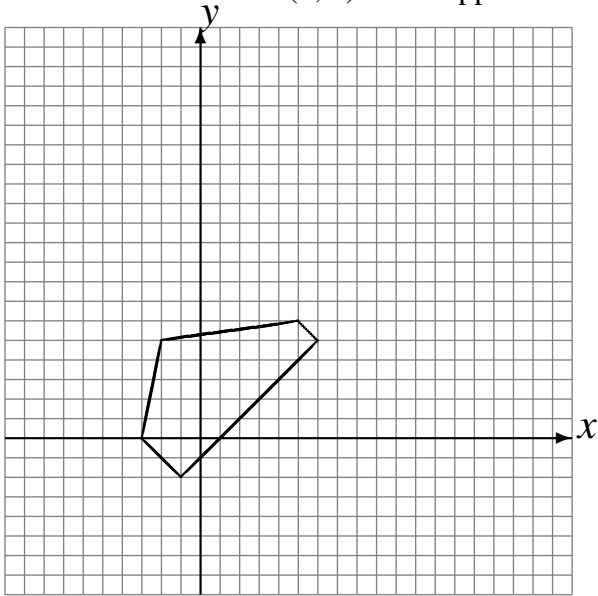

Homothétie de centre $(0, 0)$ et de rapport 3.

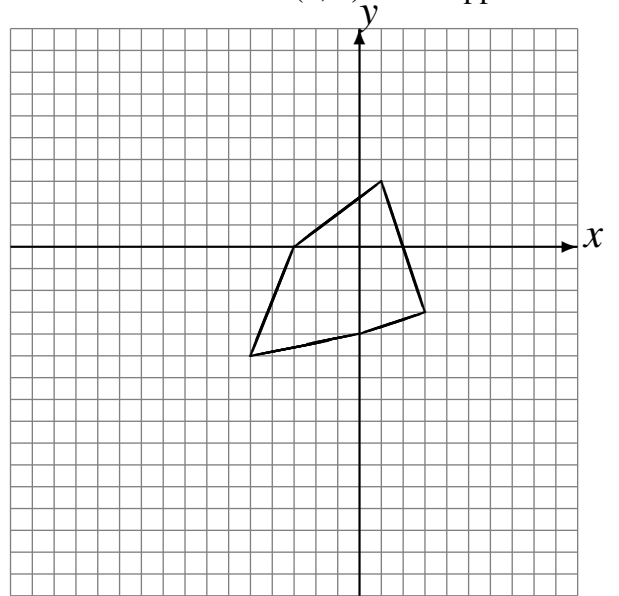

Homothétie de centre $(0, 0)$ et de rapport 3.

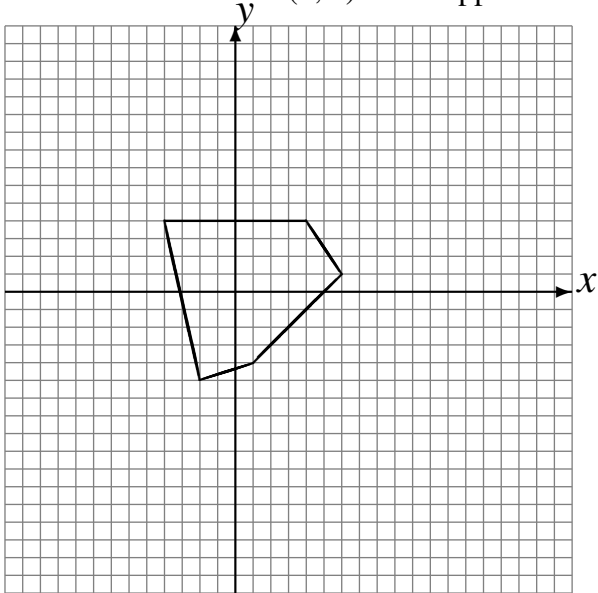

Homothétie de centre $(0, 0)$ et de rapport 3.

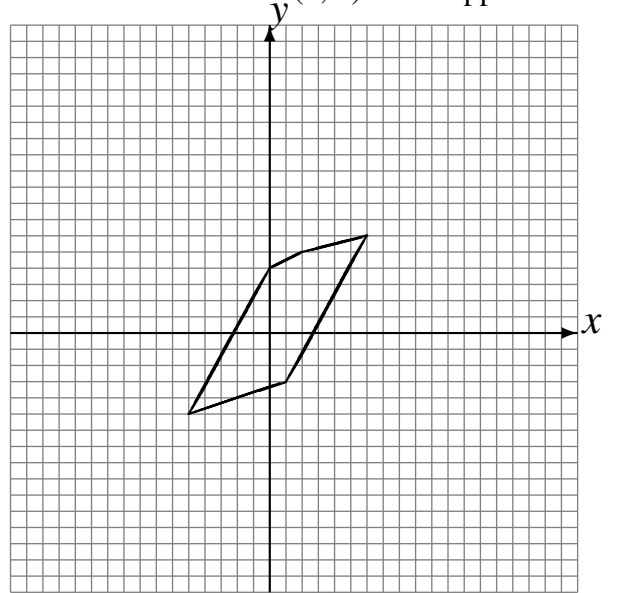

L'Homothétie (I) Solutions

Dessinez l'image de l'homothétie décrite.

Homothétie de centre $(0, 0)$ et de rapport 3.

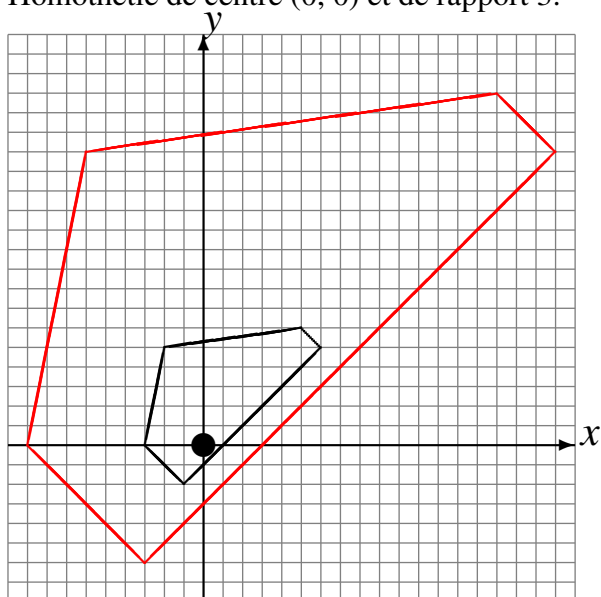

Homothétie de centre $(0, 0)$ et de rapport 3.

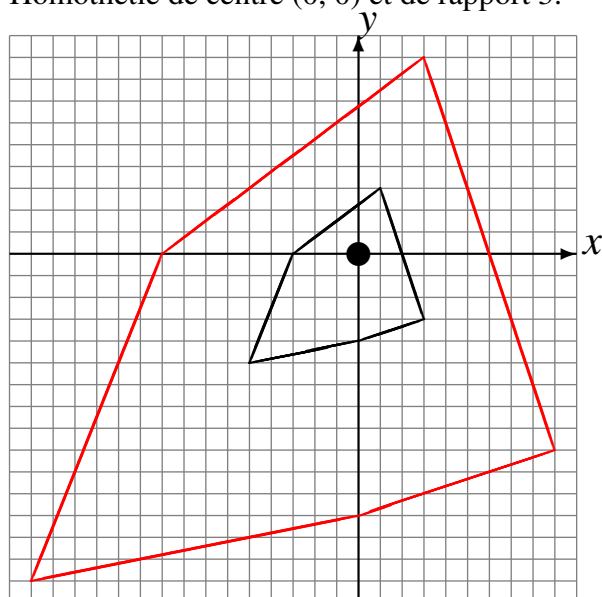

Homothétie de centre $(0, 0)$ et de rapport 3.

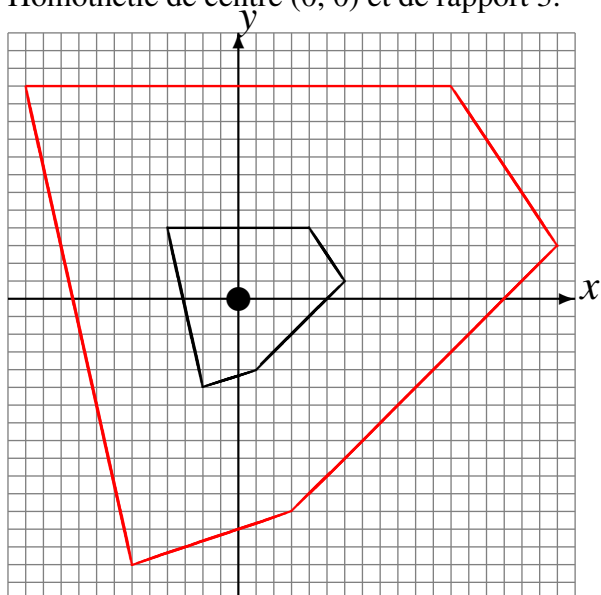

Homothétie de centre $(0, 0)$ et de rapport 3.

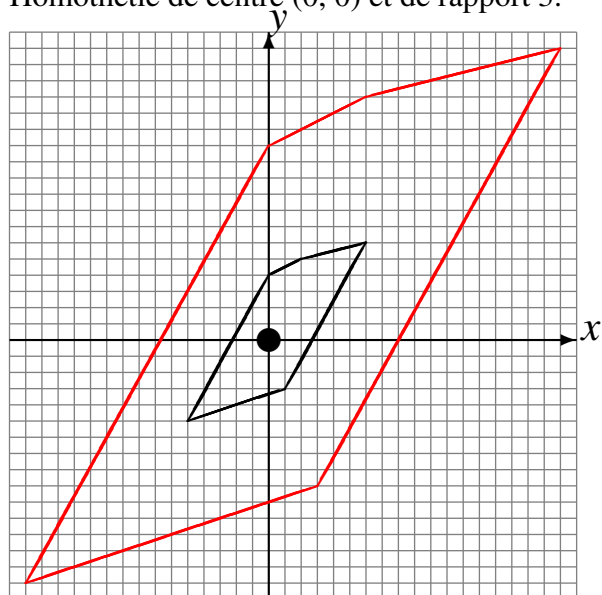

L'Homothétie (J)

Dessinez l'image de l'homothétie décrite.

Homothétie de centre $(0, 0)$ et de rapport $\frac{1}{3}$.

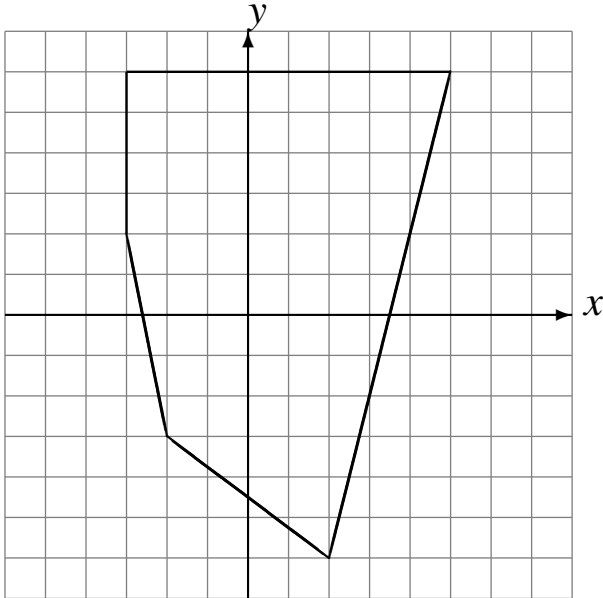

Homothétie de centre $(0, 0)$ et de rapport 4.

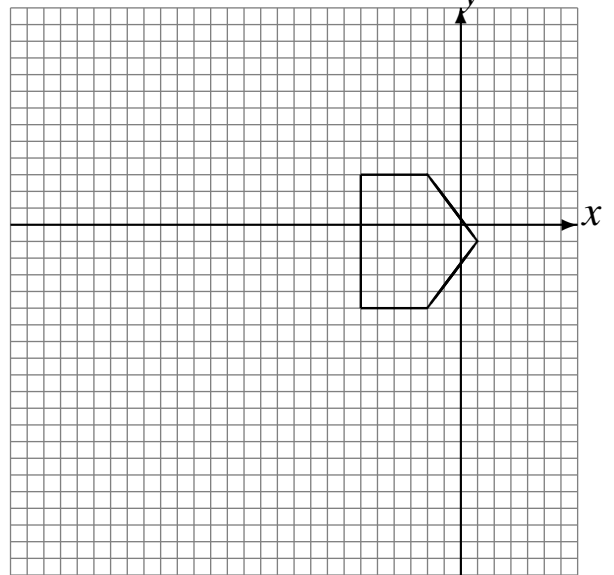

Homothétie de centre $(0, 0)$ et de rapport $\frac{1}{3}$.

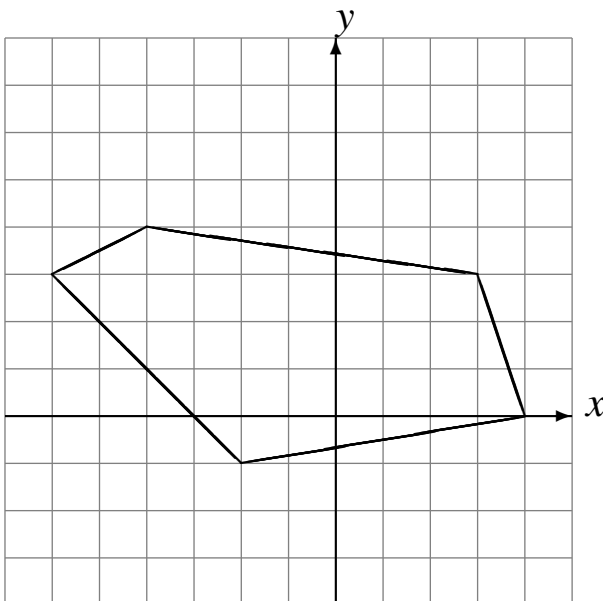

Homothétie de centre $(0, 0)$ et de rapport $\frac{1}{3}$.

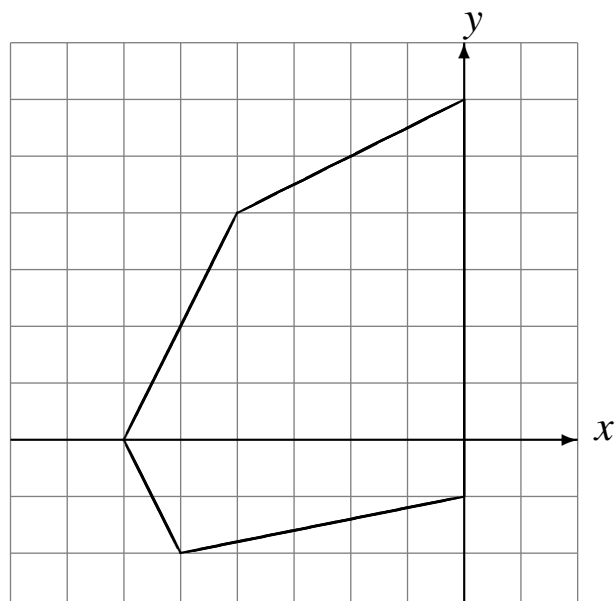

L'Homothétie (J) Solutions

Dessinez l'image de l'homothétie décrite.

Homothétie de centre $(0, 0)$ et de rapport $\frac{1}{3}$.

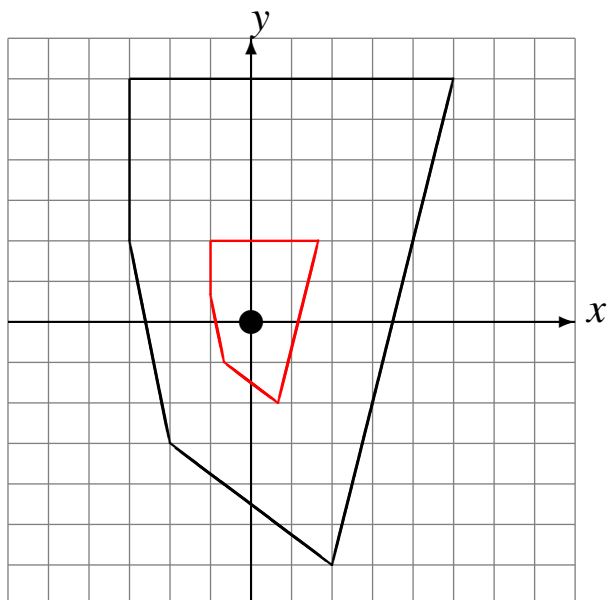

Homothétie de centre $(0, 0)$ et de rapport 4.

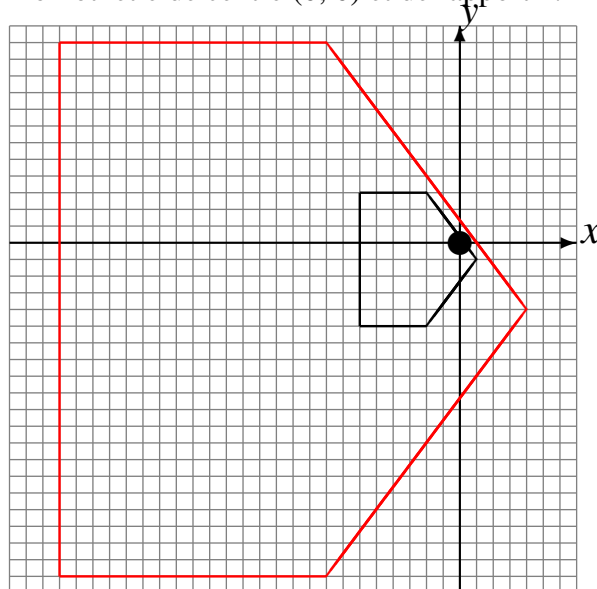

Homothétie de centre $(0, 0)$ et de rapport $\frac{1}{3}$.

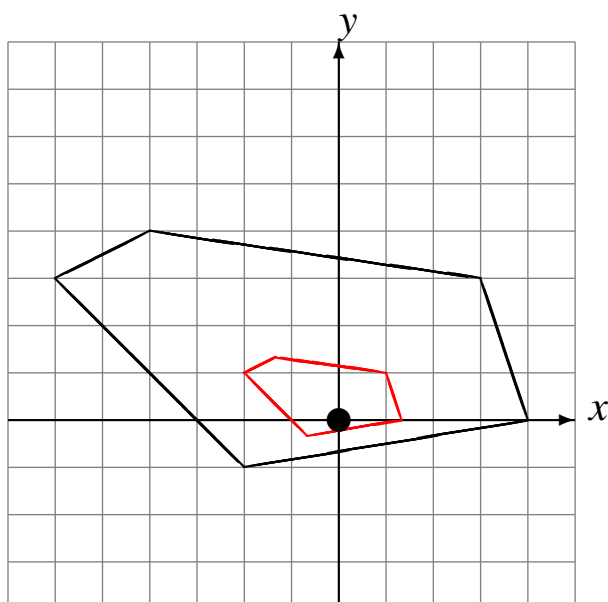

Homothétie de centre $(0, 0)$ et de rapport $\frac{1}{3}$.

