

L'Homothétie (H)

Dessinez l'image de l'homothétie décrite.

Homothétie de centre $(0, 0)$ et de rapport 4.

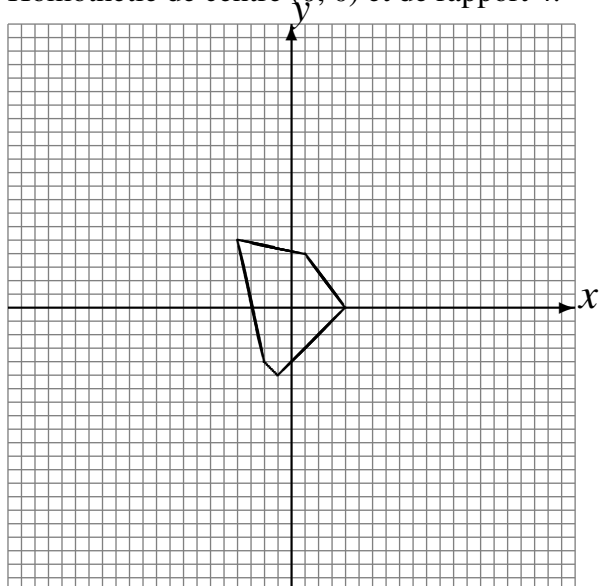

Homothétie de centre $(0, 0)$ et de rapport $\frac{1}{4}$.

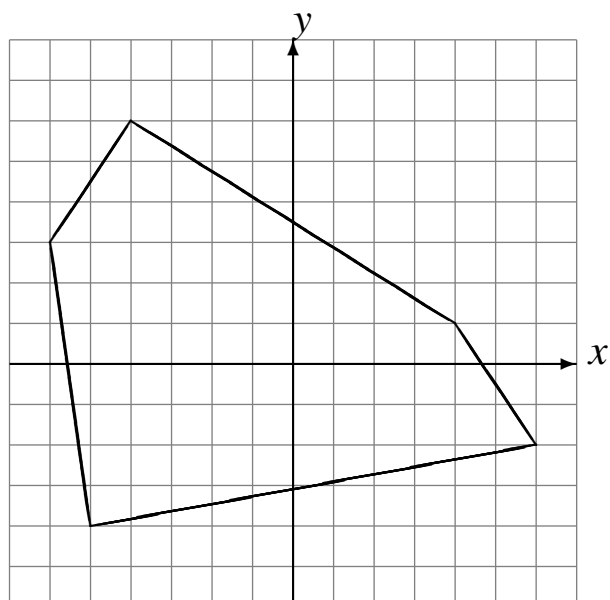

Homothétie de centre $(0, 0)$ et de rapport $\frac{1}{4}$.

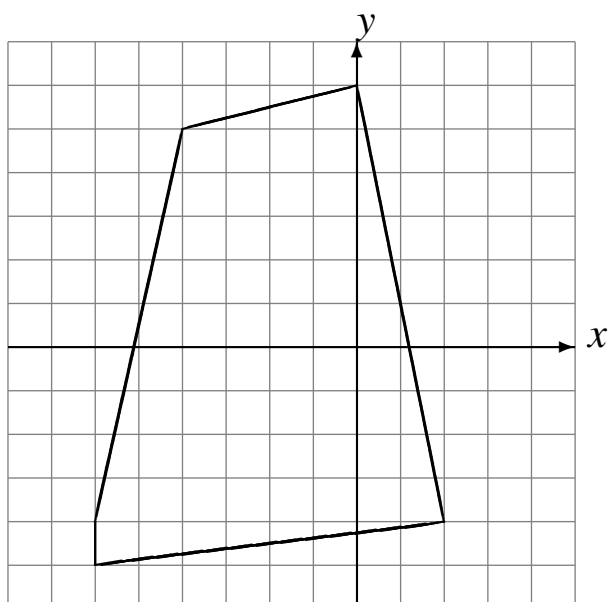

Homothétie de centre $(0, 0)$ et de rapport $\frac{1}{2}$.

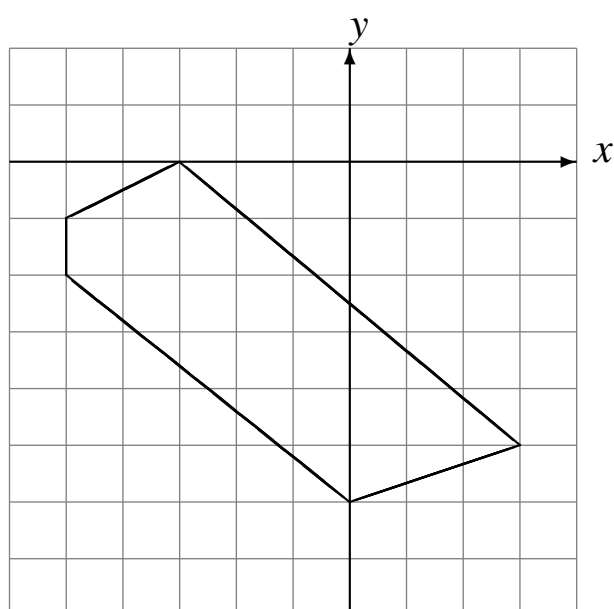

L'Homothétie (H) Solutions

Dessinez l'image de l'homothétie décrite.

Homothétie de centre $(0, 0)$ et de rapport 4.

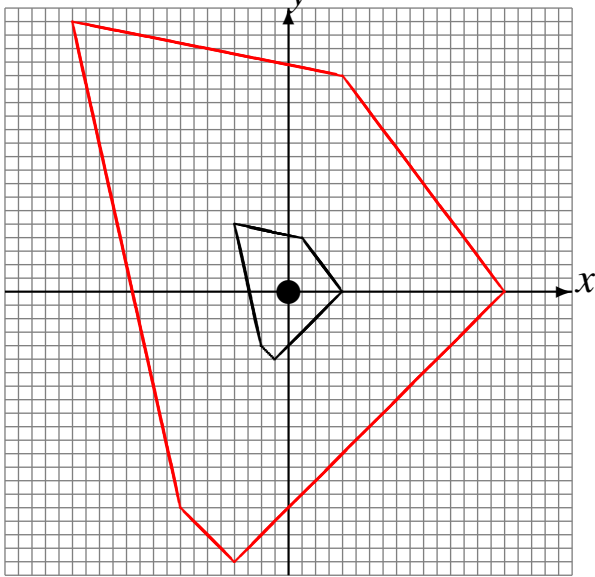

Homothétie de centre $(0, 0)$ et de rapport $\frac{1}{4}$.

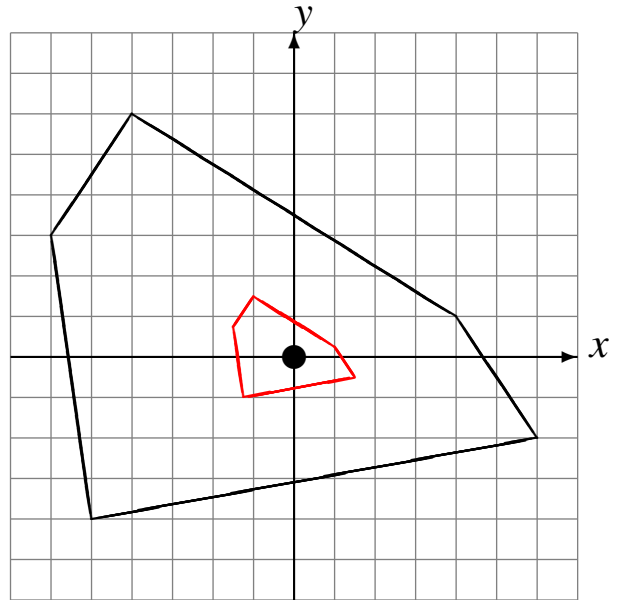

Homothétie de centre $(0, 0)$ et de rapport $\frac{1}{4}$.

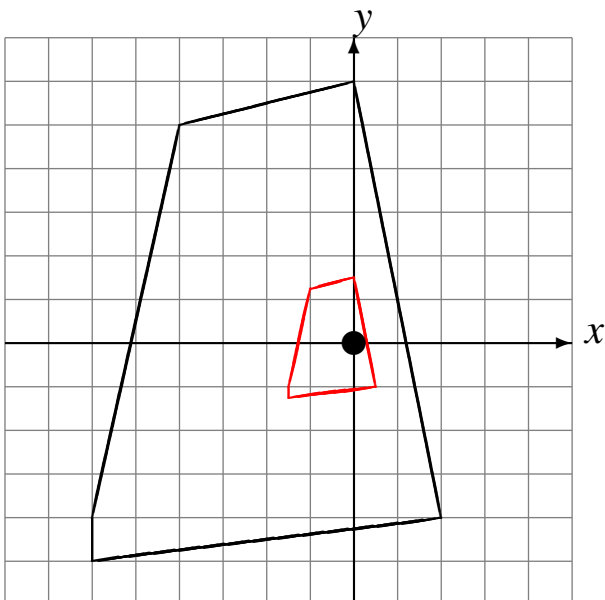

Homothétie de centre $(0, 0)$ et de rapport $\frac{1}{2}$.

