

Centres de Triangle (A)

Trouver chaque centre du triangle donné

1. - orthocentre

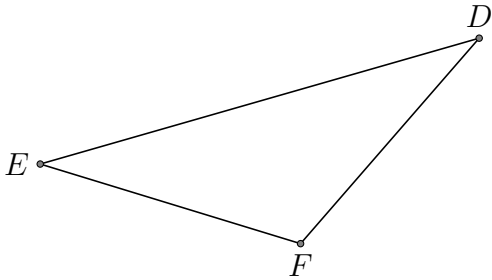

2. - orthocentre

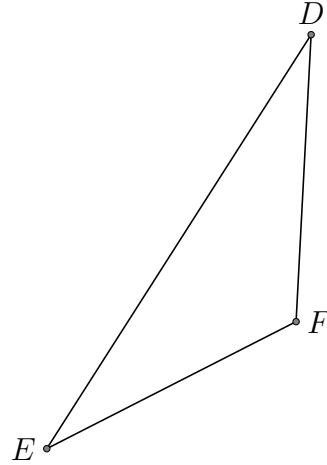

3. - orthocentre

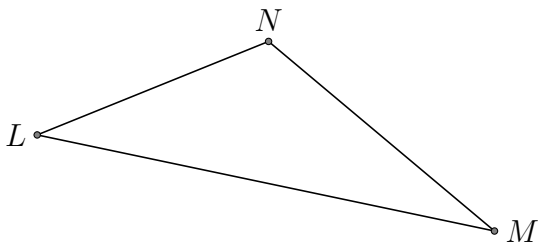

4. - orthocentre

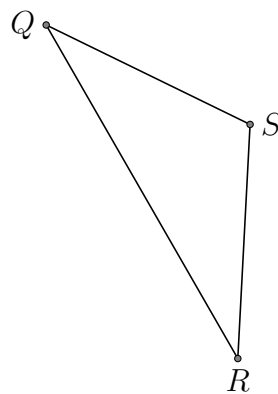

Centres de Triangle (A) Réponses

Trouver chaque centre du triangle donné

1. - orthocentre

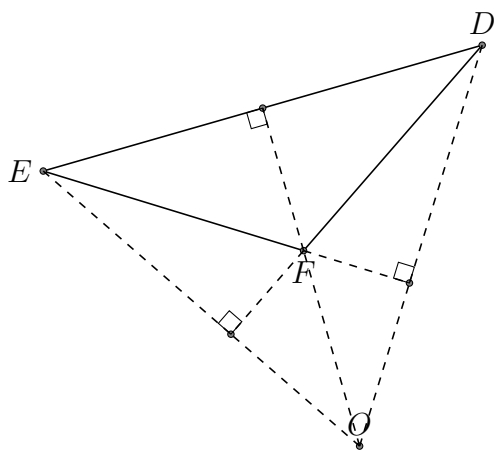

2. - orthocentre

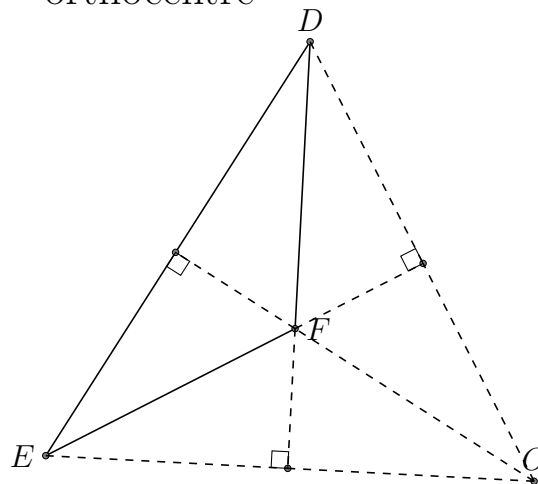

3. - orthocentre

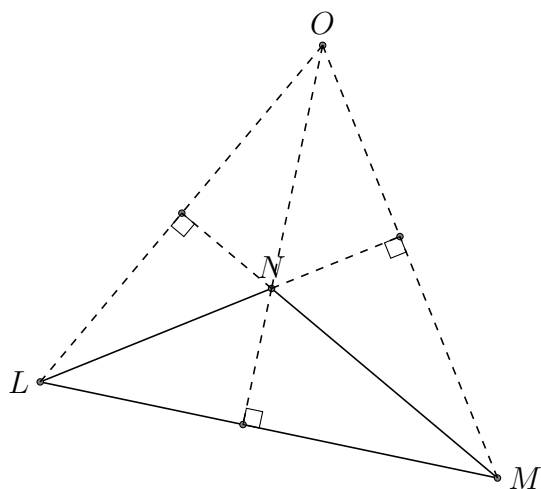

4. - orthocentre

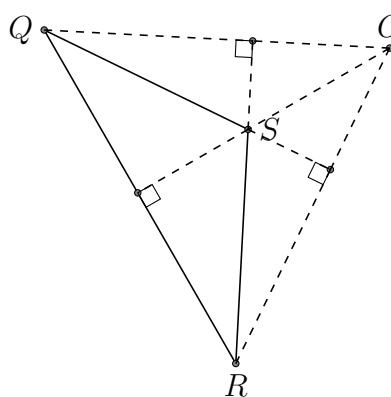

Centres de Triangle (B)

Trouver chaque centre du triangle donné

1. - orthocentre

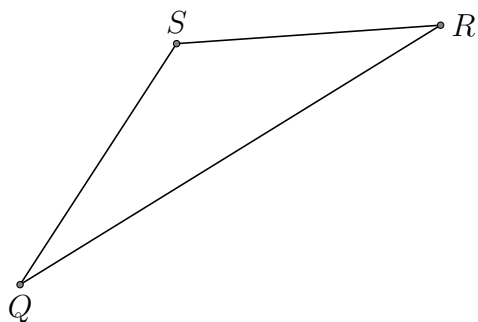

2. - orthocentre

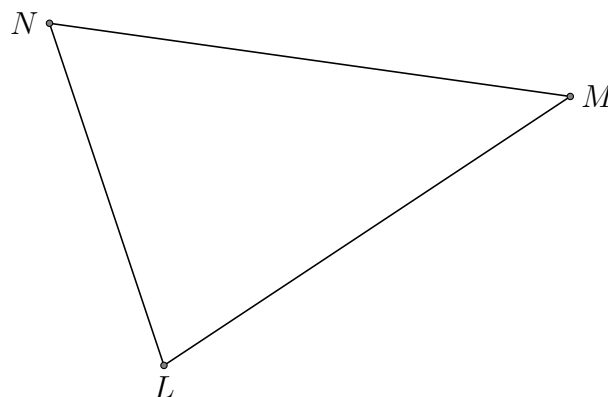

3. - orthocentre

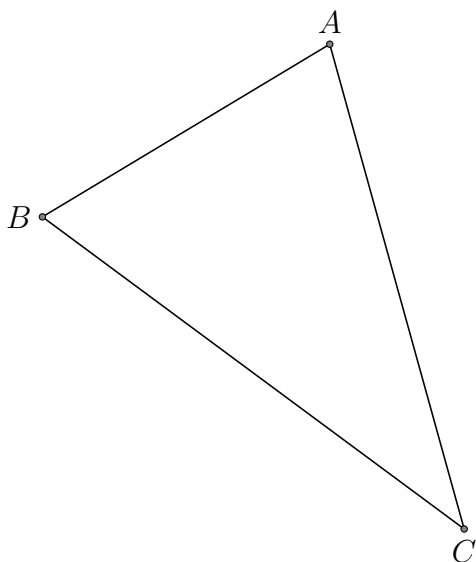

4. - orthocentre

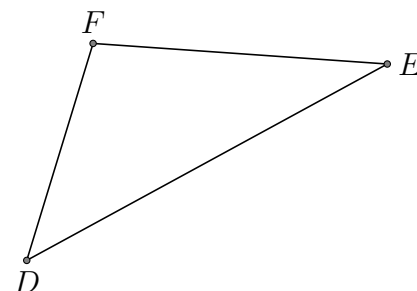

Centres de Triangle (B) Réponses

Trouver chaque centre du triangle donné

1. - orthocentre

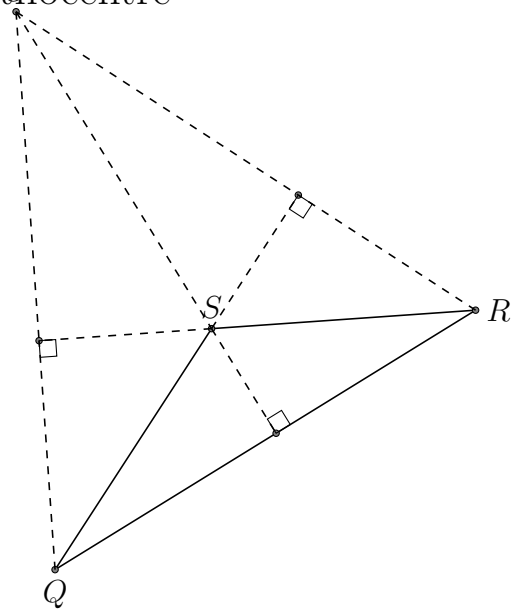

2. - orthocentre

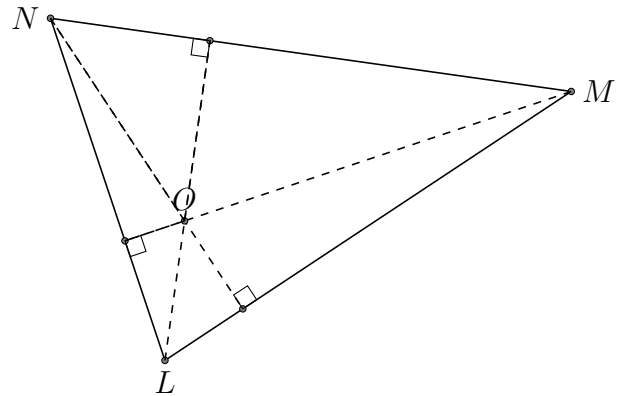

3. - orthocentre

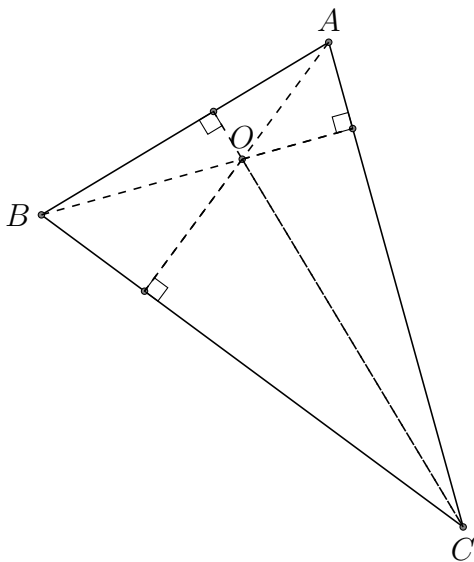

4. - orthocentre

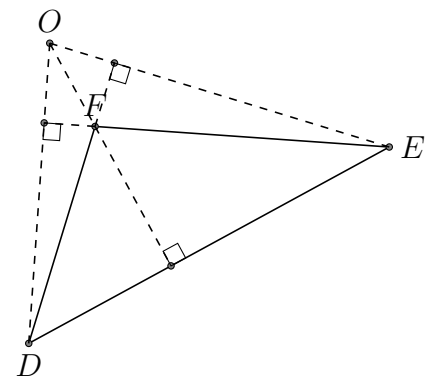

Centres de Triangle (C)

Trouver chaque centre du triangle donné

1. - orthocentre

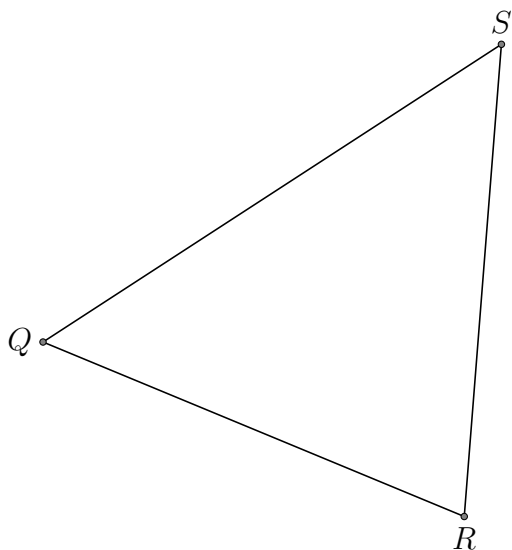

2. - orthocentre

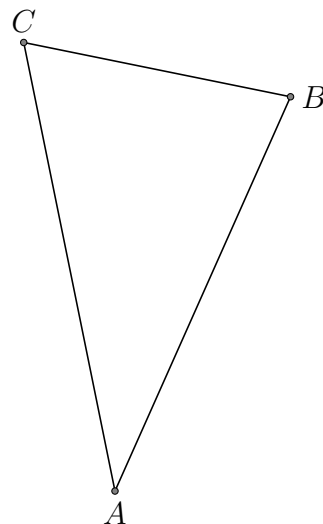

3. - orthocentre

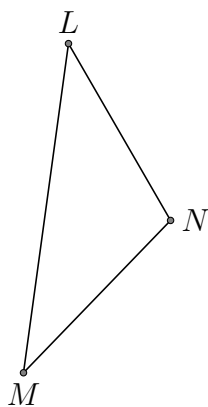

4. - orthocentre

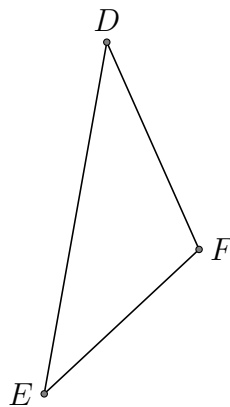

Centres de Triangle (C) Réponses

Trouver chaque centre du triangle donné

1. - orthocentre

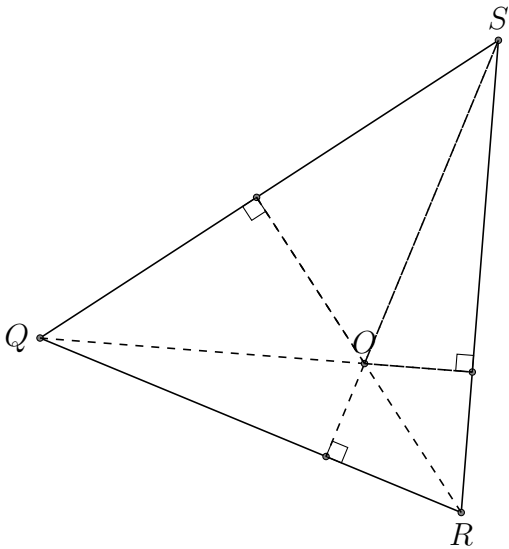

2. - orthocentre

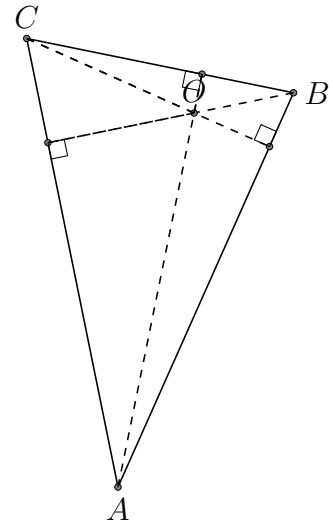

3. - orthocentre

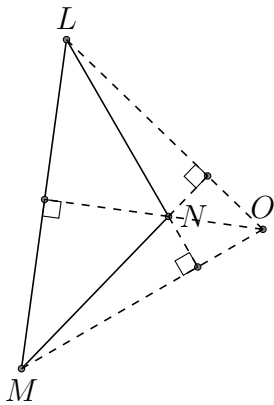

4. - orthocentre

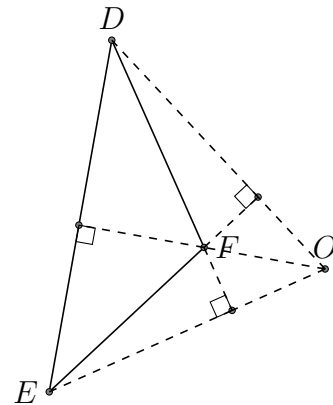

Centres de Triangle (D)

Trouver chaque centre du triangle donné

1. - orthocentre

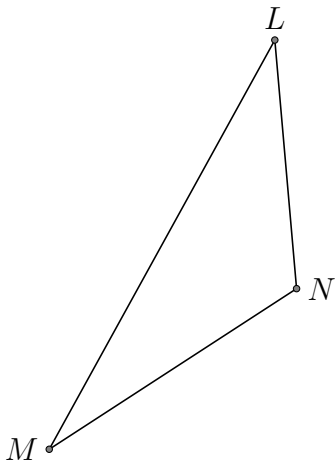

2. - orthocentre

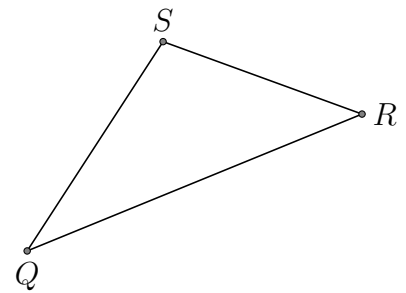

3. - orthocentre

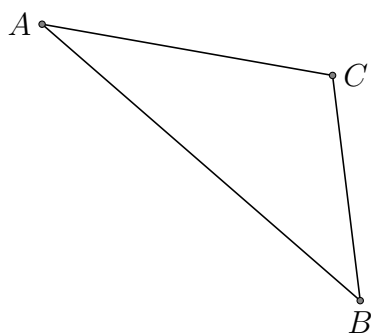

4. - orthocentre

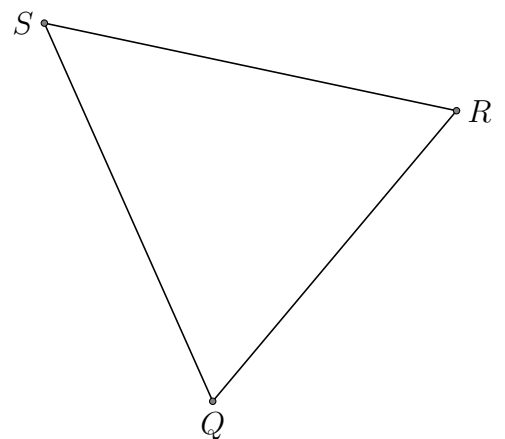

Centres de Triangle (D) Réponses

Trouver chaque centre du triangle donné

1. - orthocentre

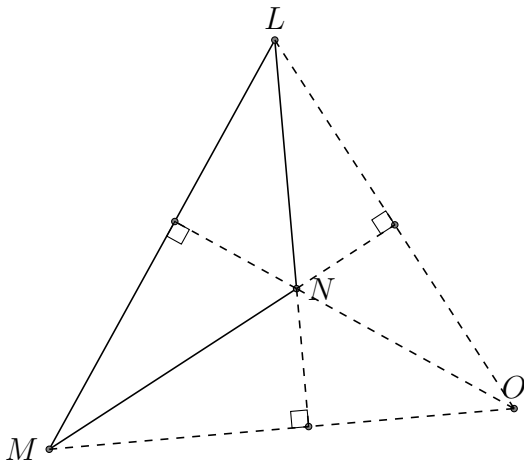

2. - orthocentre

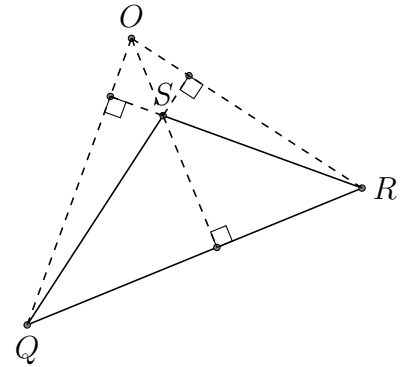

3. - orthocentre

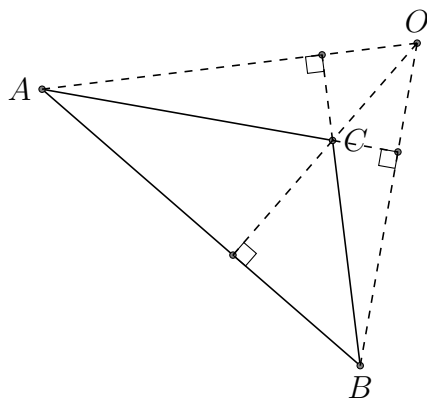

4. - orthocentre

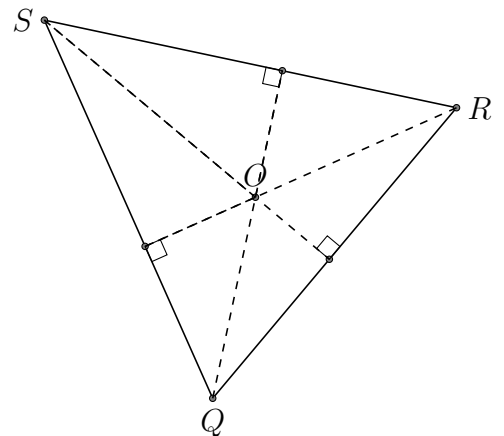

Centres de Triangle (E)

Trouver chaque centre du triangle donné

1. - orthocentre

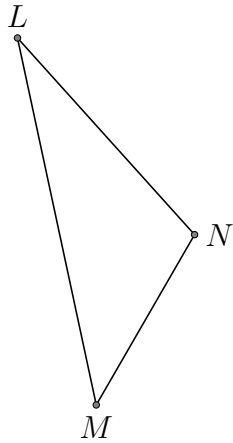

2. - orthocentre

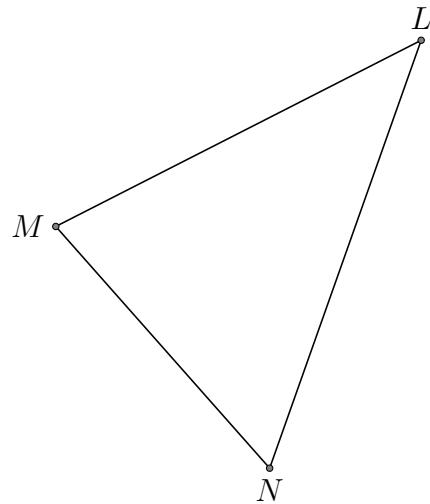

3. - orthocentre

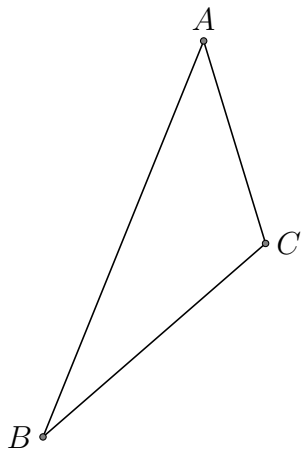

4. - orthocentre

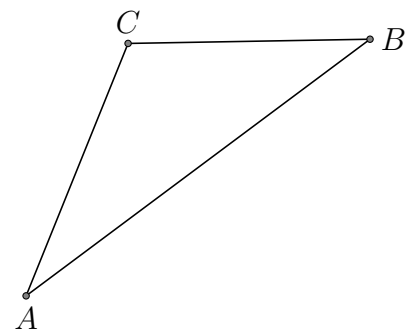

Centres de Triangle (E) Réponses

Trouver chaque centre du triangle donné

1. - orthocentre

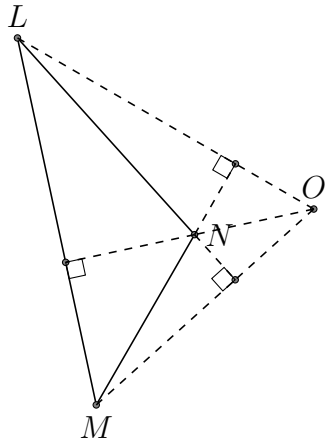

2. - orthocentre

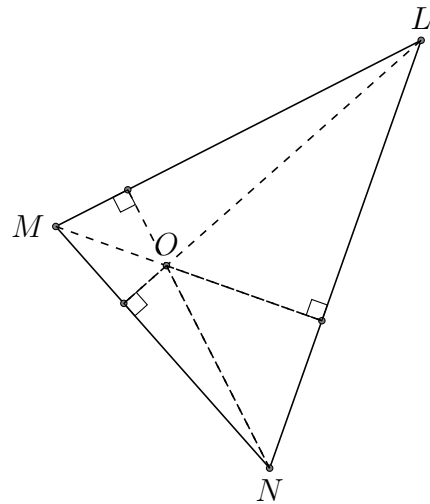

3. - orthocentre

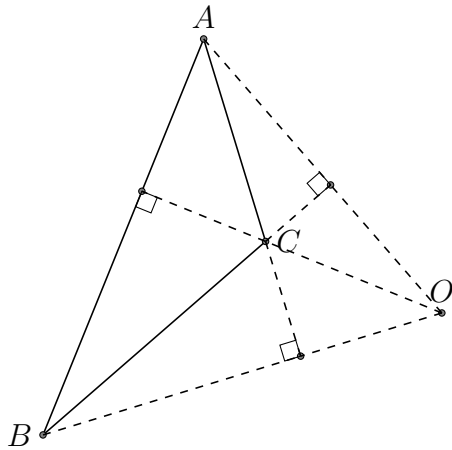

4. - orthocentre

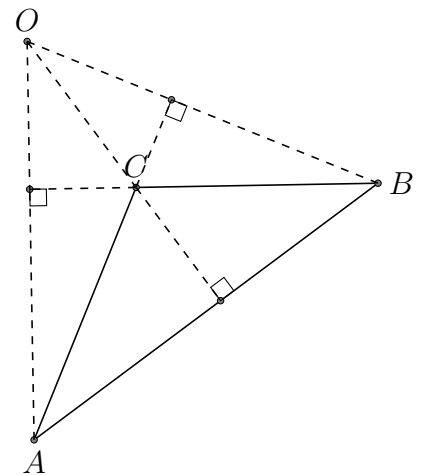

Centres de Triangle (F)

Trouver chaque centre du triangle donné

1. - orthocentre

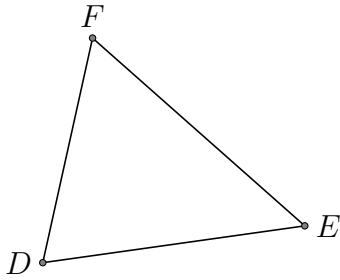

2. - orthocentre

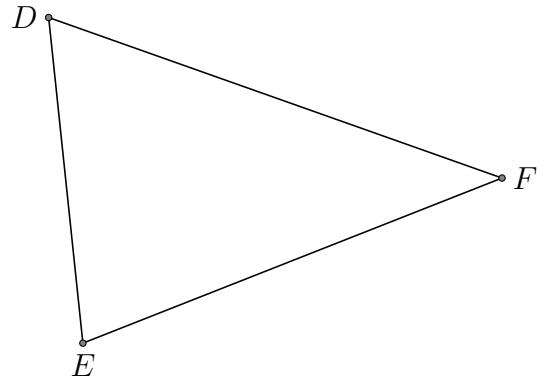

3. - orthocentre

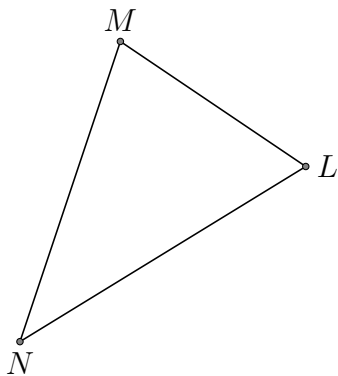

4. - orthocentre

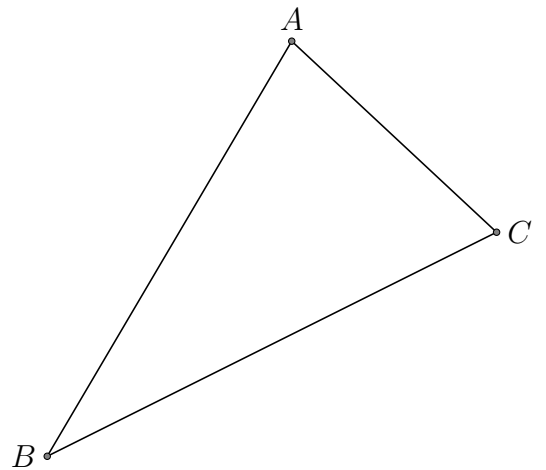

Centres de Triangle (F) Réponses

Trouver chaque centre du triangle donné

1. - orthocentre

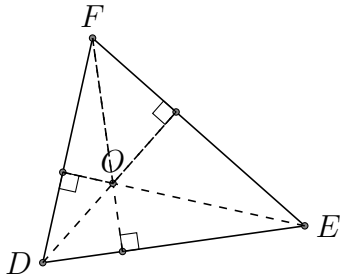

2. - orthocentre

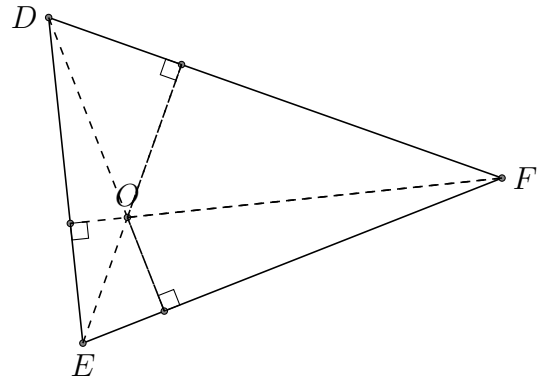

3. - orthocentre

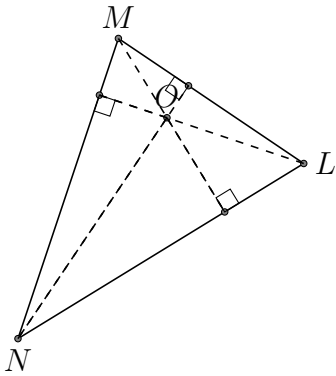

4. - orthocentre

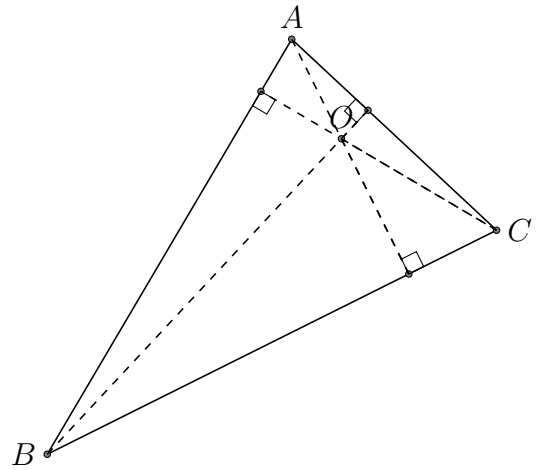

Centres de Triangle (G)

Trouver chaque centre du triangle donné

1. - orthocentre

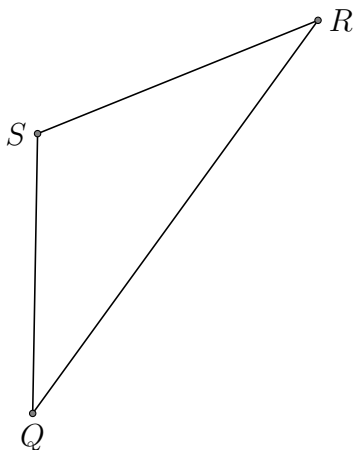

2. - orthocentre

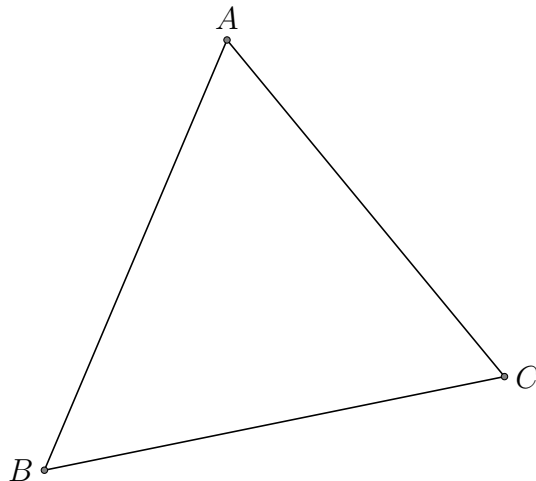

3. - orthocentre

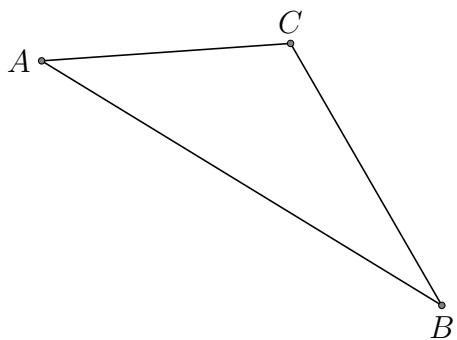

4. - orthocentre

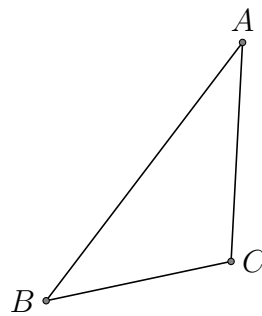

Centres de Triangle (G) Réponses

Trouver chaque centre du triangle donné

1. - orthocentre

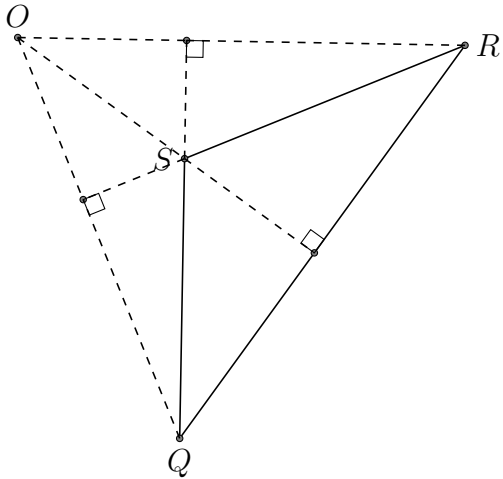

2. - orthocentre

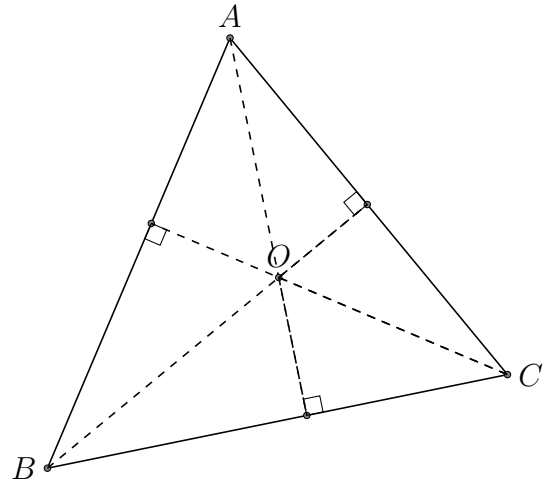

3. - orthocentre

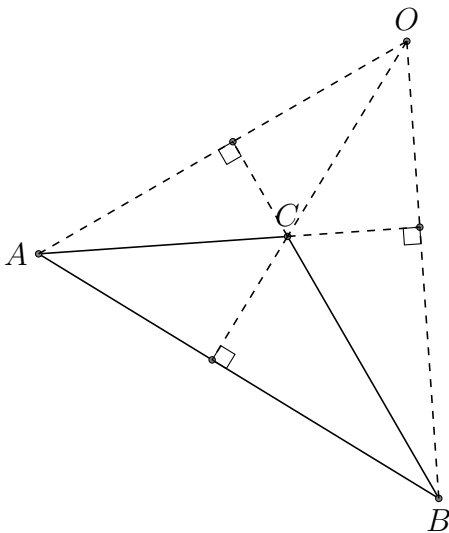

4. - orthocentre

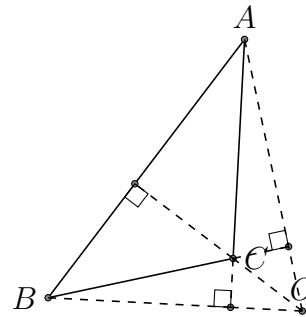

Centres de Triangle (H)

Trouver chaque centre du triangle donné

1. - orthocentre

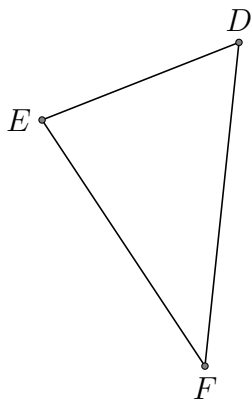

2. - orthocentre

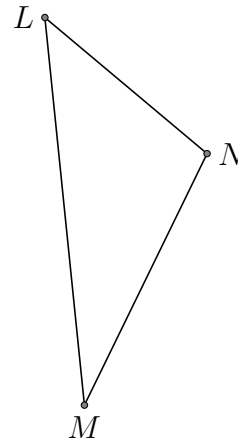

3. - orthocentre

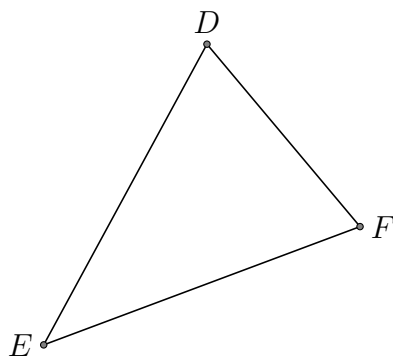

4. - orthocentre

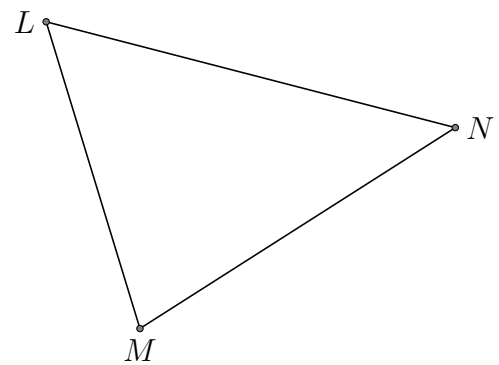

Centres de Triangle (H) Réponses

Trouver chaque centre du triangle donné

1. - orthocentre

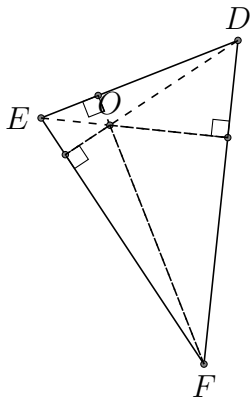

2. - orthocentre

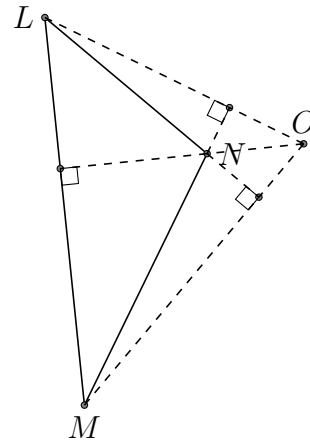

3. - orthocentre

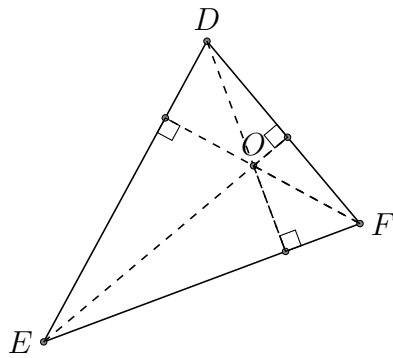

4. - orthocentre

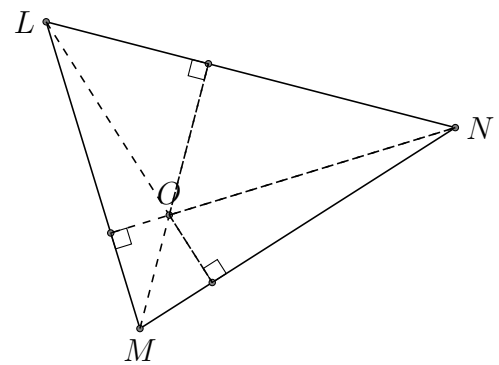

Centres de Triangle (I)

Trouver chaque centre du triangle donné

1. - orthocentre

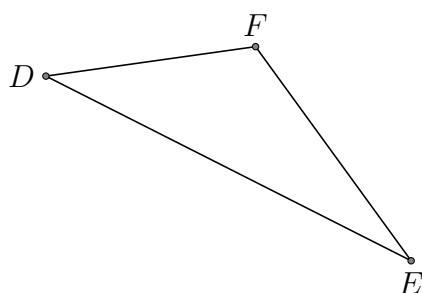

2. - orthocentre

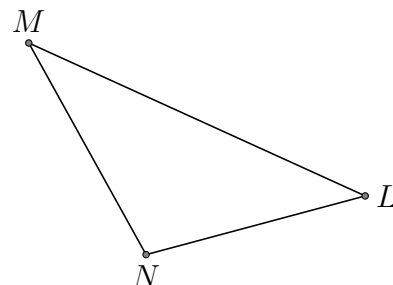

3. - orthocentre

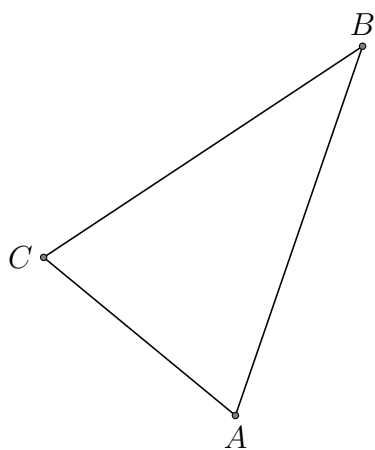

4. - orthocentre

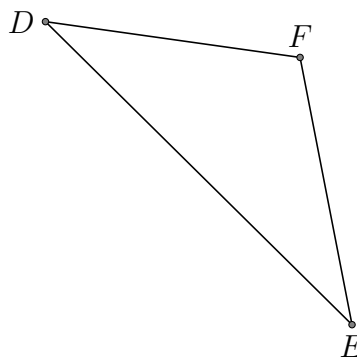

Centres de Triangle (I) Réponses

Trouver chaque centre du triangle donné

1. - orthocentre

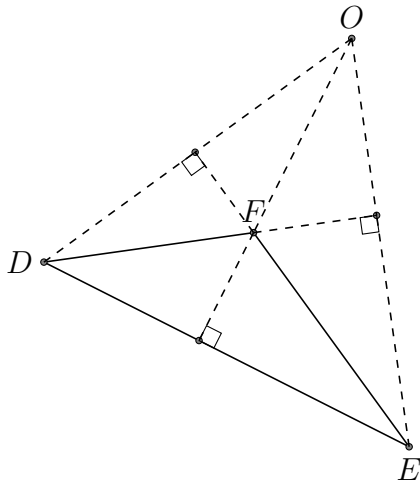

2. - orthocentre

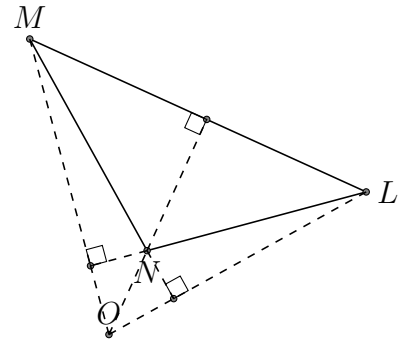

3. - orthocentre

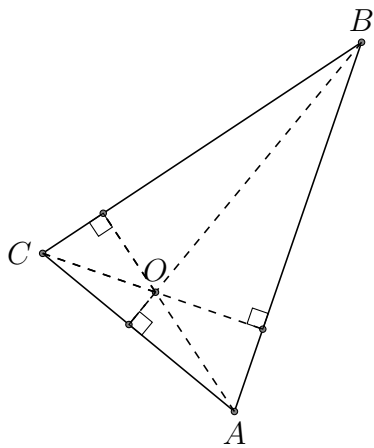

4. - orthocentre

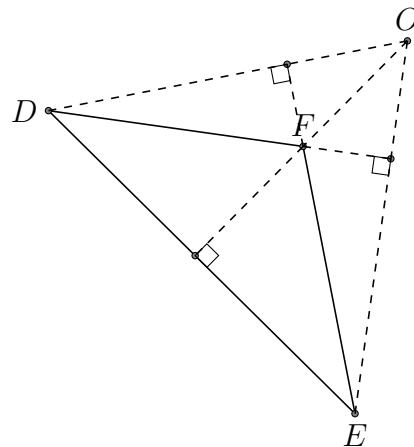

Centres de Triangle (J)

Trouver chaque centre du triangle donné

1. - orthocentre

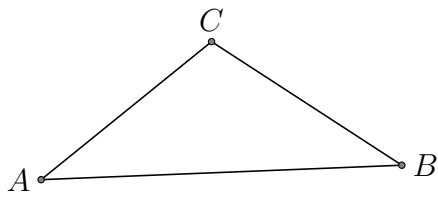

2. - orthocentre

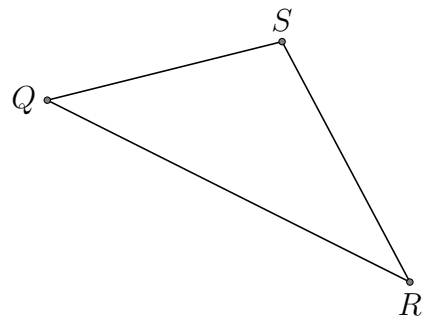

3. - orthocentre

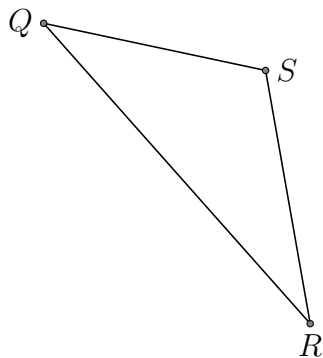

4. - orthocentre

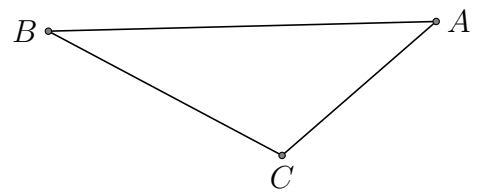

Centres de Triangle (J) Réponses

Trouver chaque centre du triangle donné

1. - orthocentre

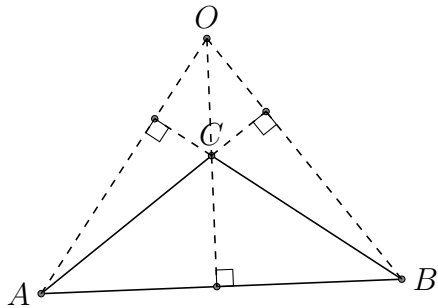

2. - orthocentre

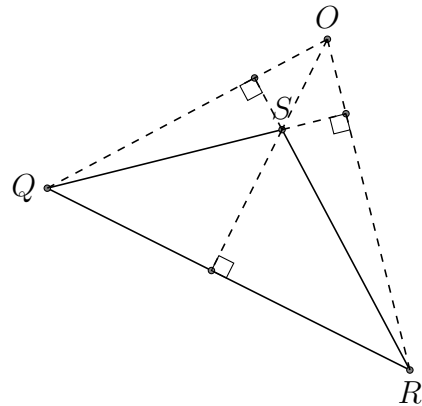

3. - orthocentre

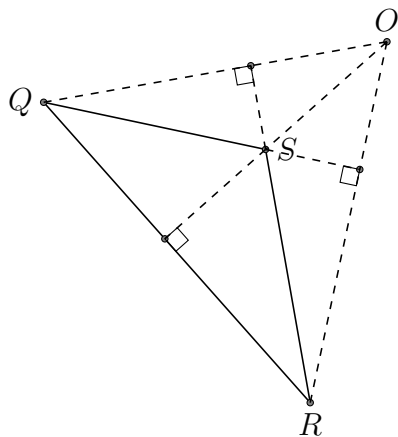

4. - orthocentre

