

# Bissectrices d'un Angle (A)

Construire la bissectrice pour chaque angle.

1.

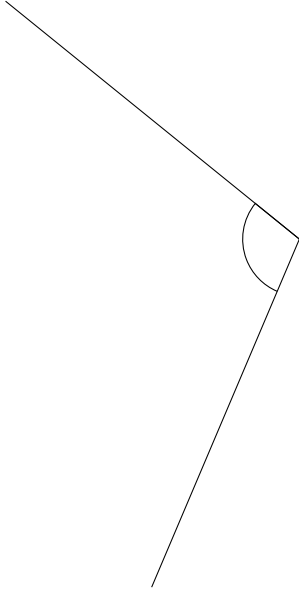

2.

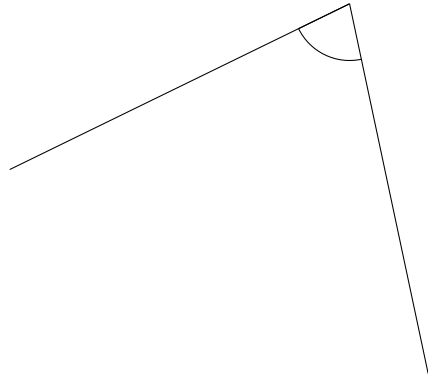

3.

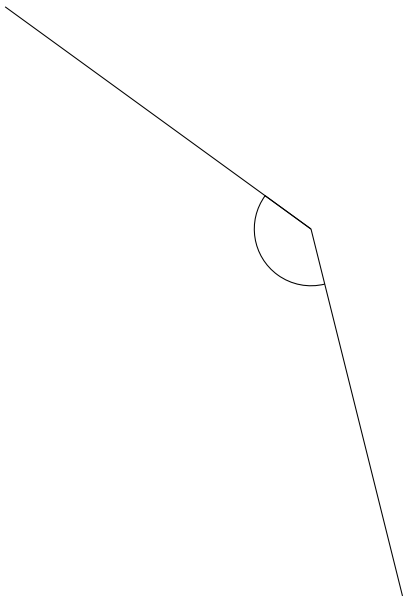

4.

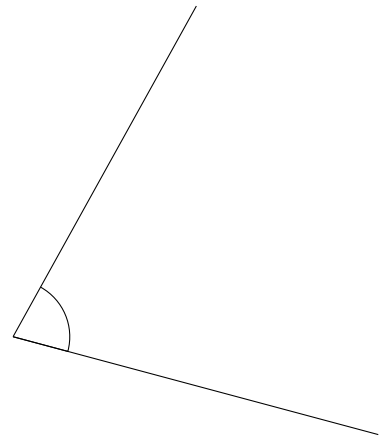

# Bissectrices d'un Angle (A) Solutions

Construire la bissectrice pour chaque angle.

1.

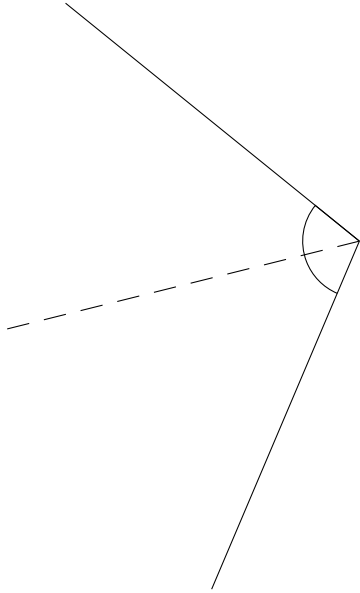

2.

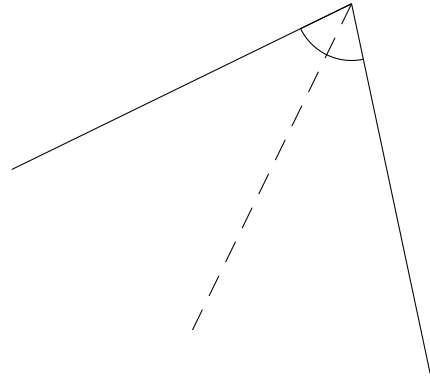

3.

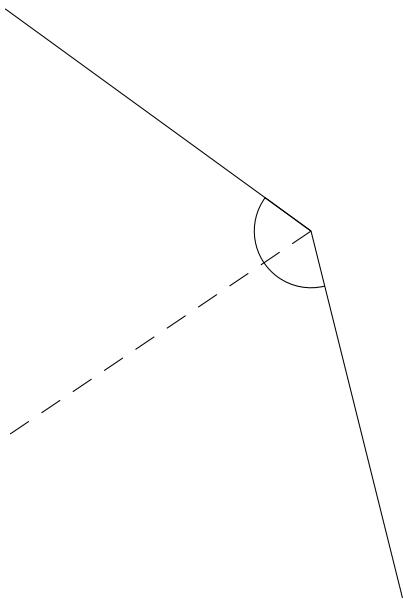

4.

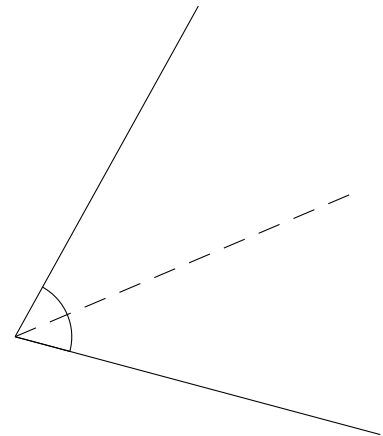

# Bissectrices d'un Angle (B)

Construire la bissectrice pour chaque angle.

1.

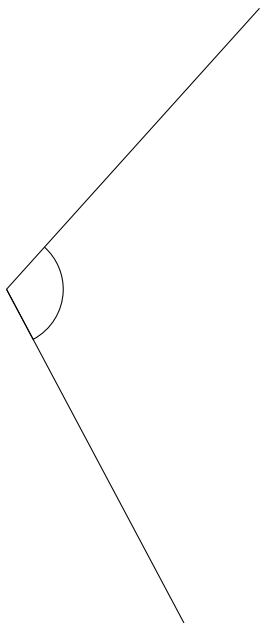

2.

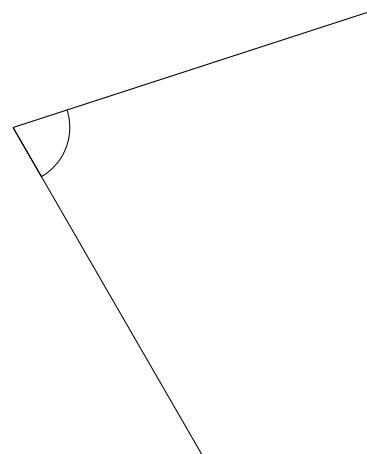

3.

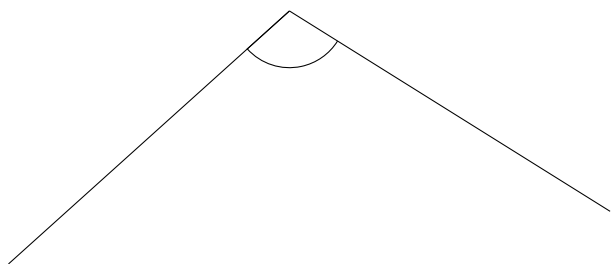

4.

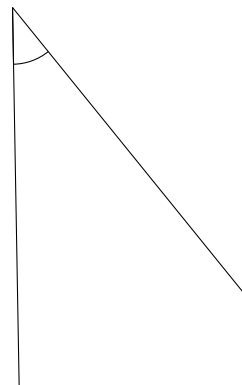

# Bissectrices d'un Angle (B) Solutions

Construire la bissectrice pour chaque angle.

1.

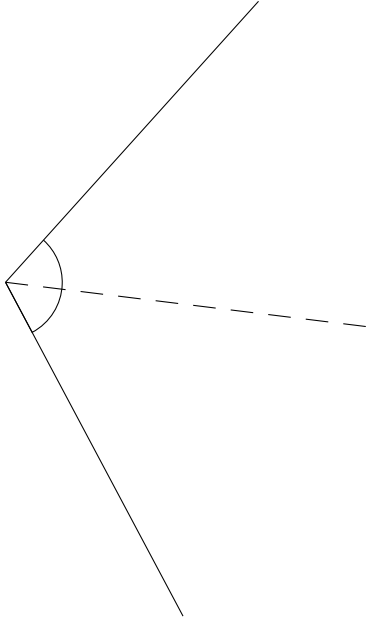

2.

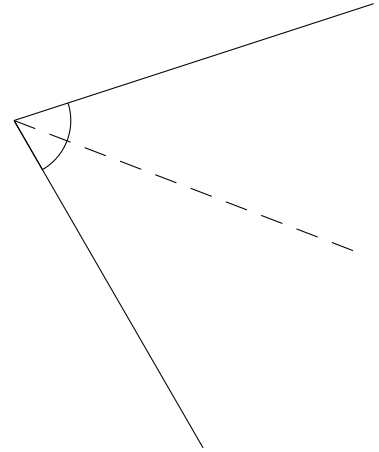

3.

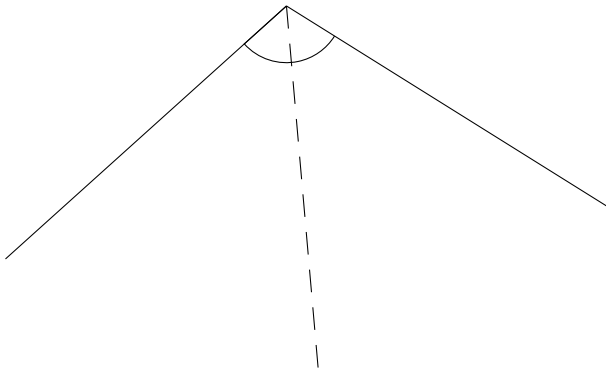

4.

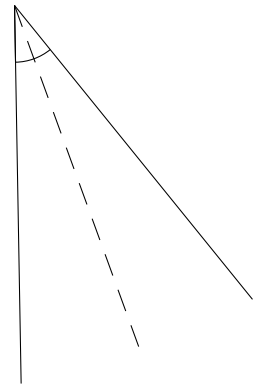

# Bissectrices d'un Angle (C)

Construire la bissectrice pour chaque angle.

1.

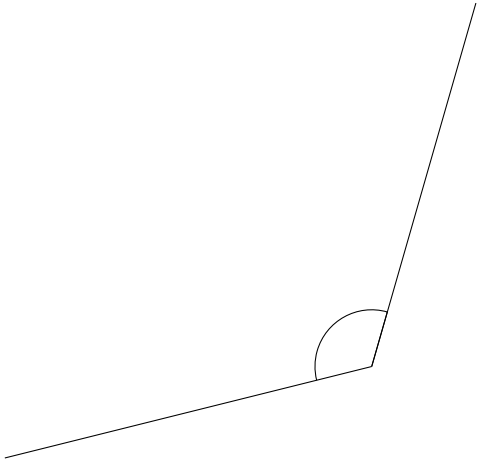

2.

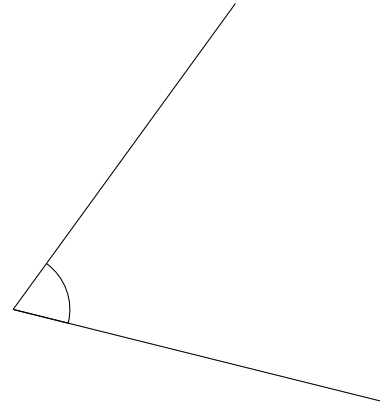

3.

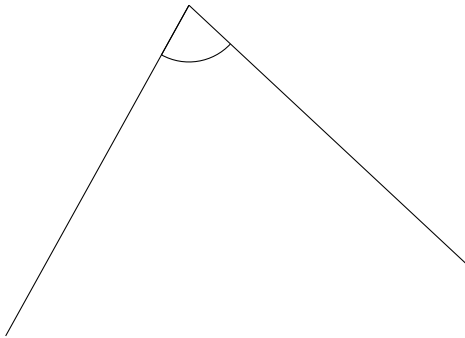

4.

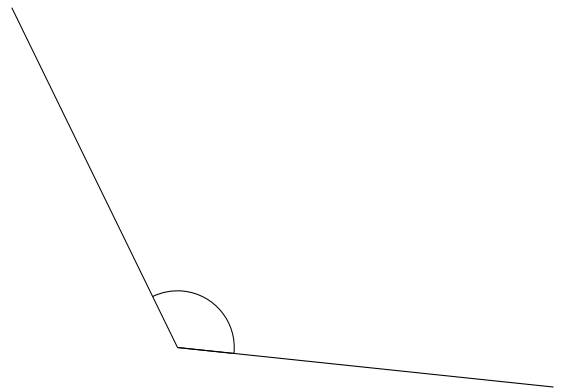

# Bissectrices d'un Angle (C) Solutions

Construire la bissectrice pour chaque angle.

1.

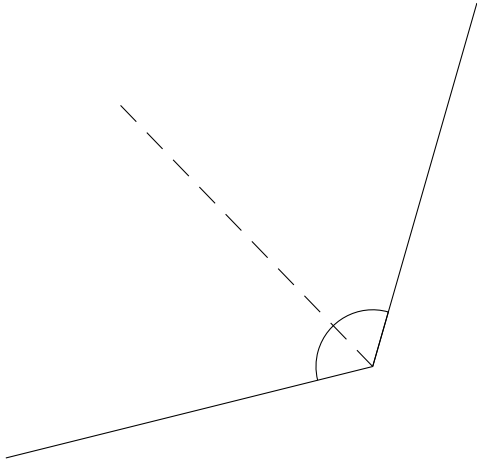

2.

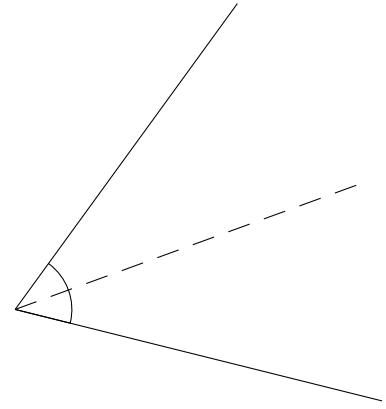

3.

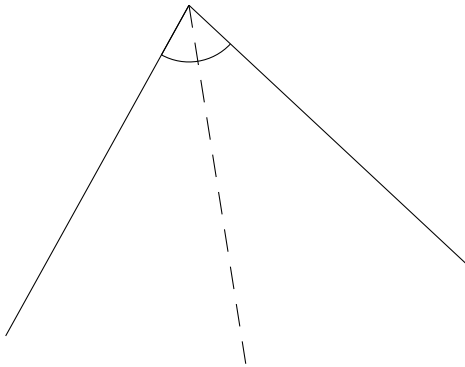

4.

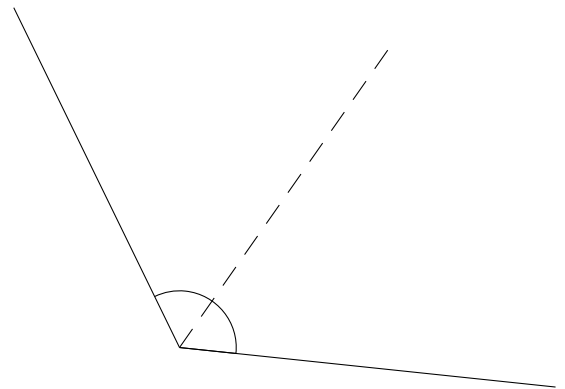

# Bissectrices d'un Angle (D)

Construire la bissectrice pour chaque angle.

1.

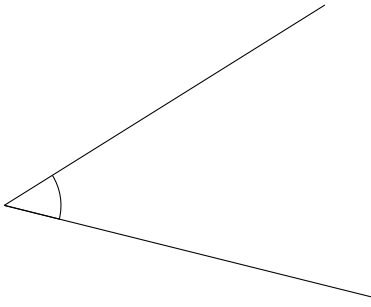

2.

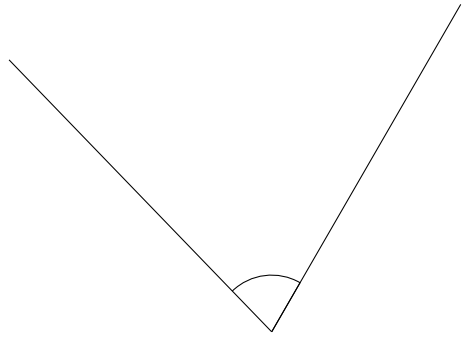

3.

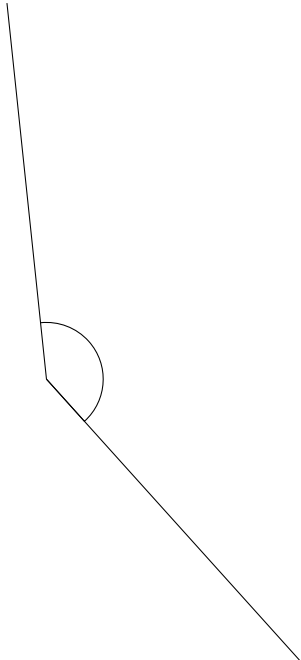

4.

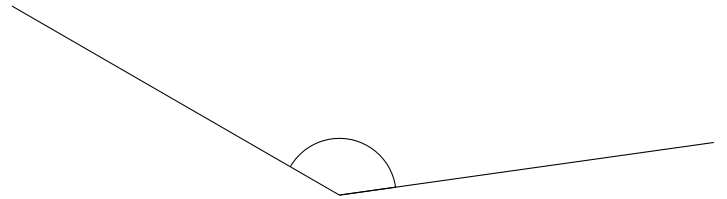

# Bissectrices d'un Angle (D) Solutions

Construire la bissectrice pour chaque angle.

1.

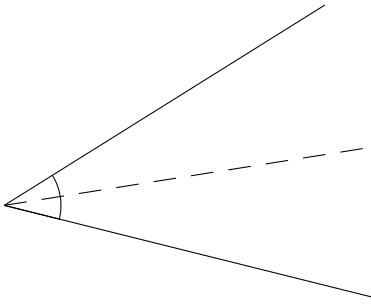

2.

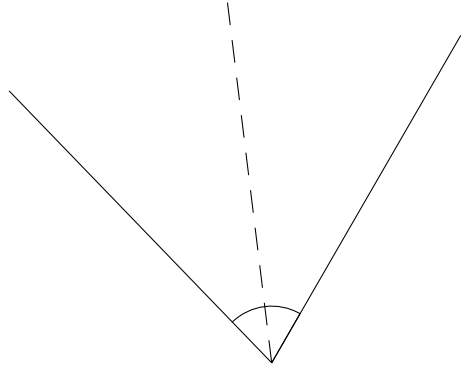

3.

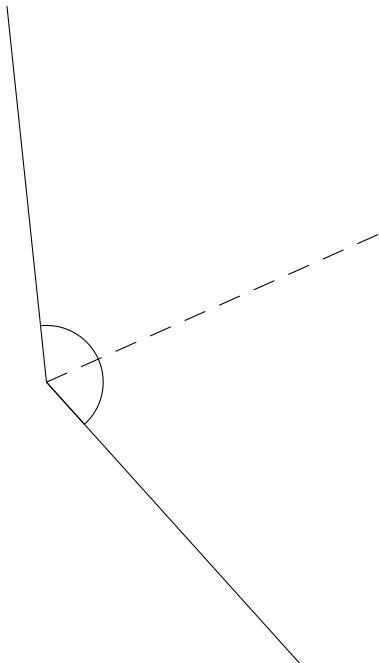

4.

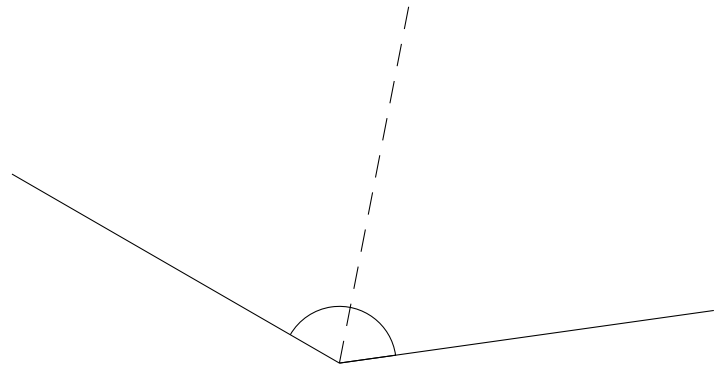



# Bissectrices d'un Angle (E)

Construire la bissectrice pour chaque angle.

1.

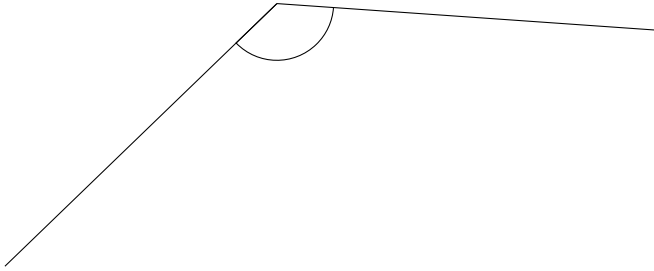

2.

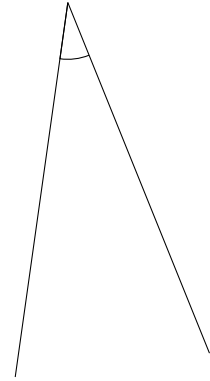

3.

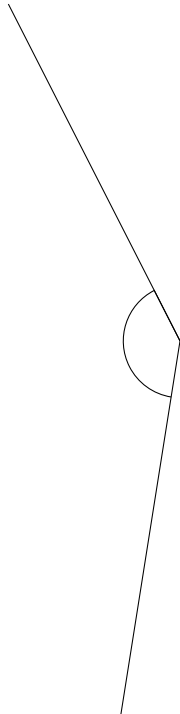

4.

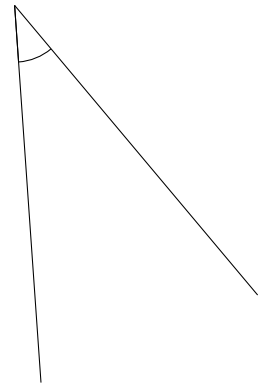

# Bissectrices d'un Angle (E) Solutions

Construire la bissectrice pour chaque angle.

1.

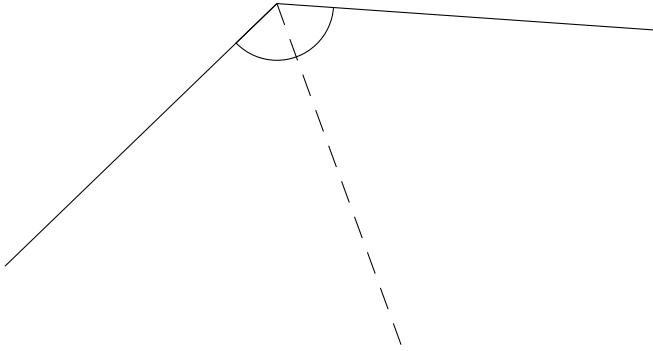

2.

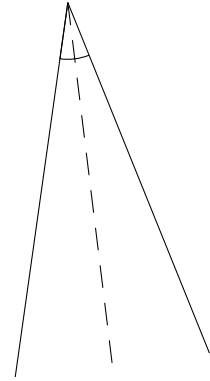

3.

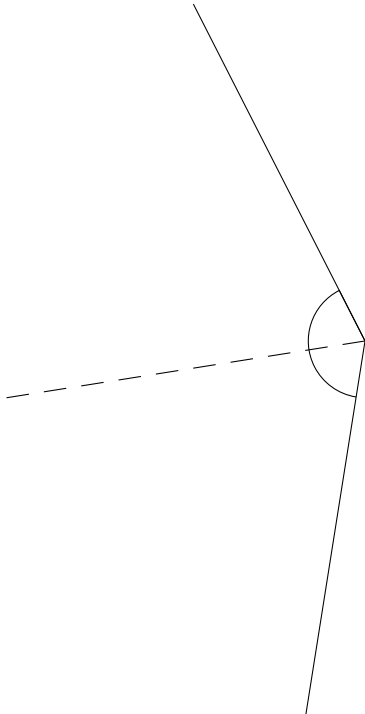

4.

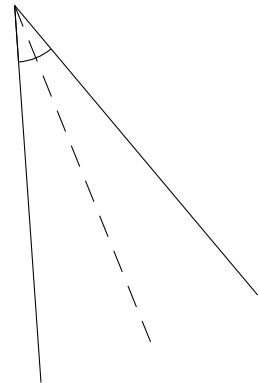

# Bissectrices d'un Angle (F)

Construire la bissectrice pour chaque angle.

1.

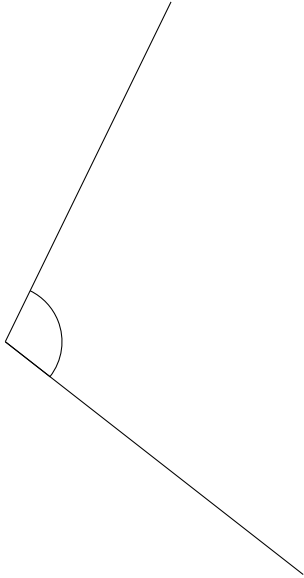

2.

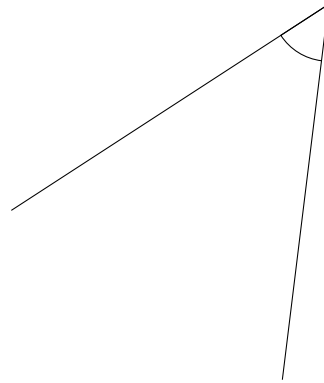

3.

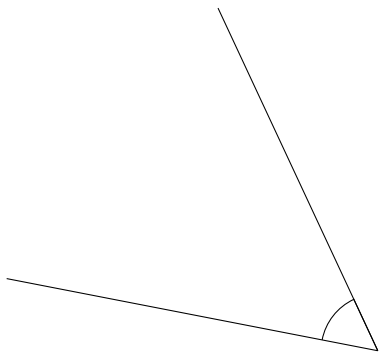

4.

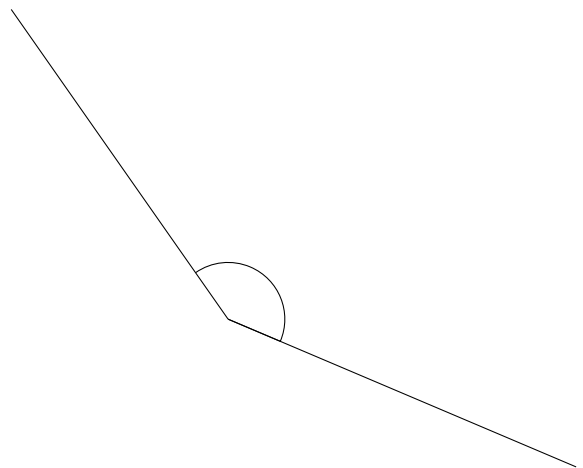

# Bissectrices d'un Angle (F) Solutions

Construire la bissectrice pour chaque angle.

1.

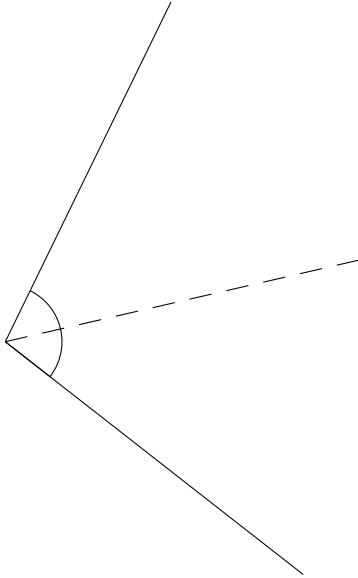

2.

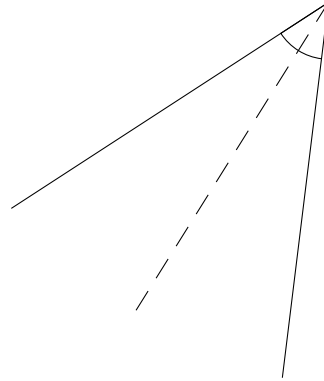

3.

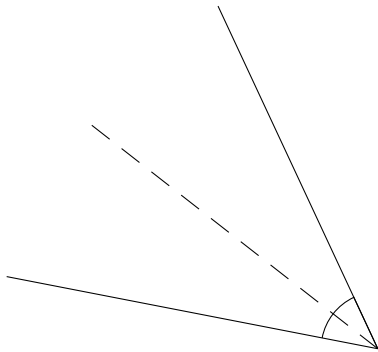

4.

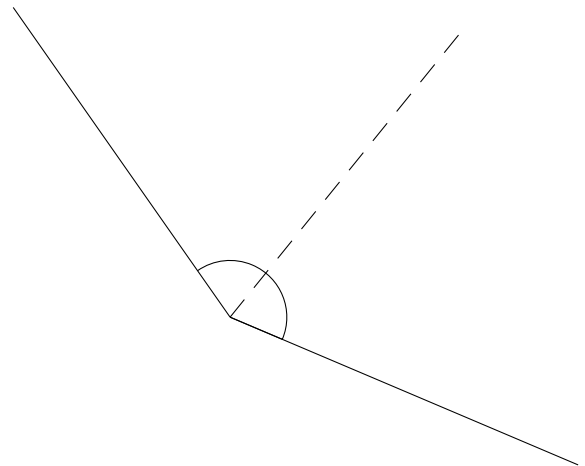

# Bissectrices d'un Angle (G)

Construire la bissectrice pour chaque angle.

1.

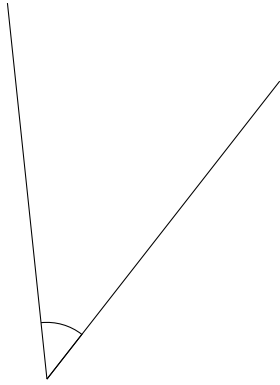

2.

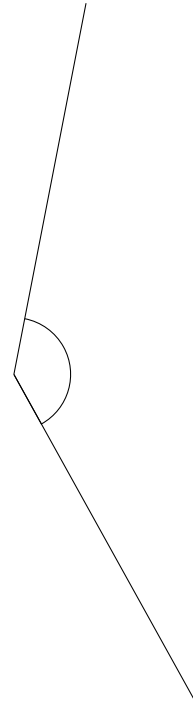

3.

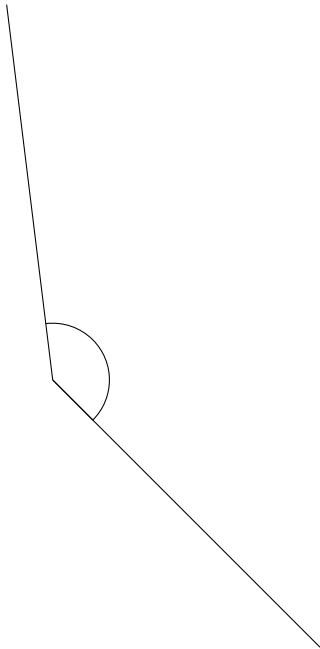

4.

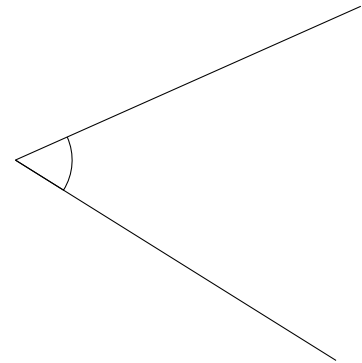

# Bissectrices d'un Angle (G) Solutions

Construire la bissectrice pour chaque angle.

1.

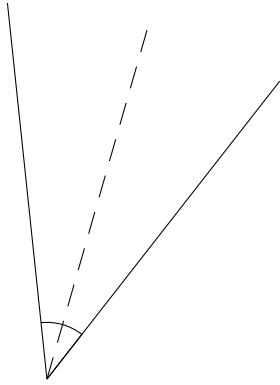

2.

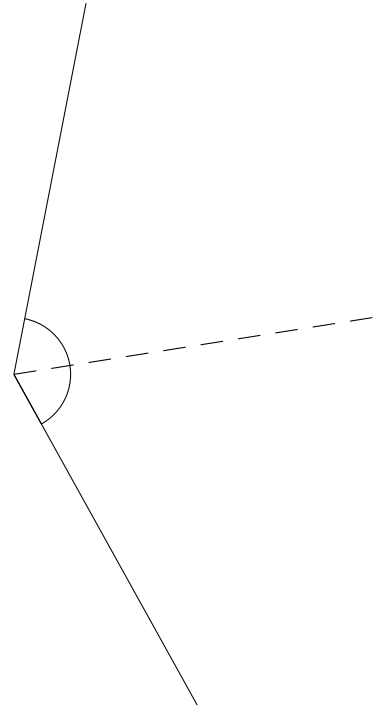

3.

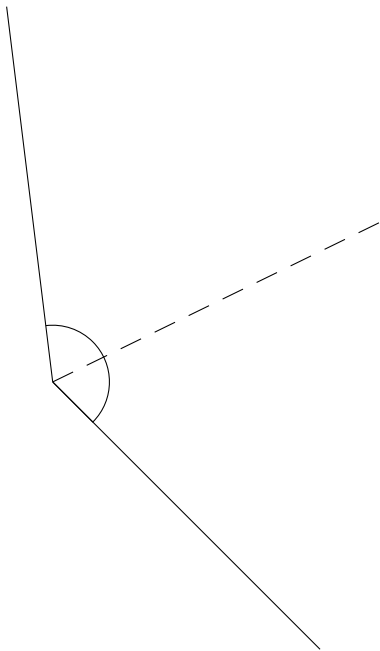

4.

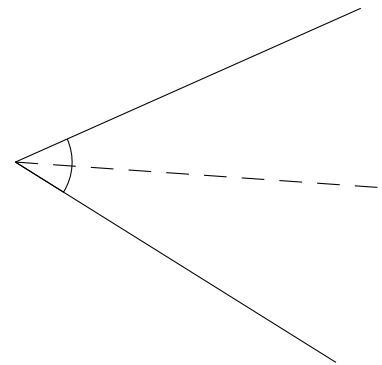

# Bissectrices d'un Angle (H)

Construire la bissectrice pour chaque angle.

1.

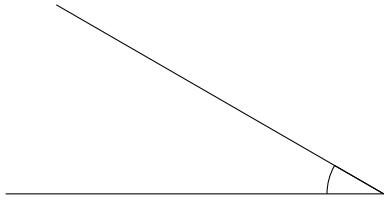

2.

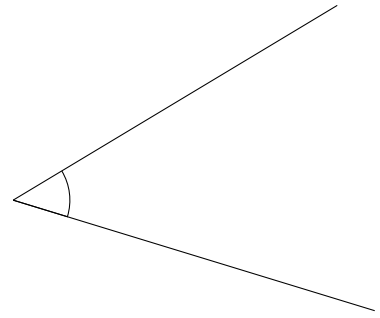

3.

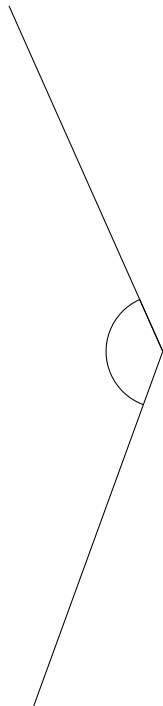

4.

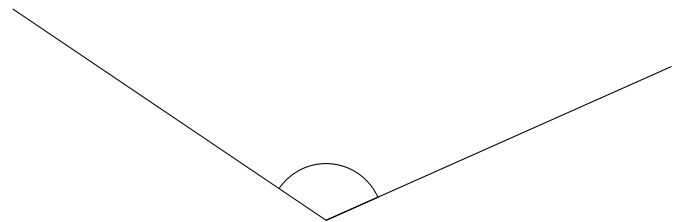

# Bissectrices d'un Angle (H) Solutions

Construire la bissectrice pour chaque angle.

1.

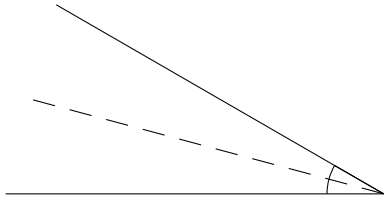

2.

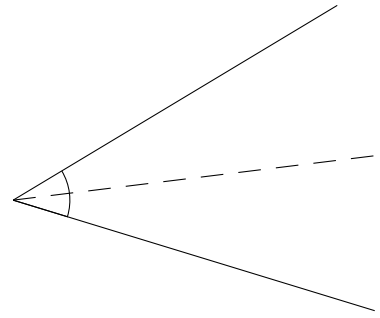

3.

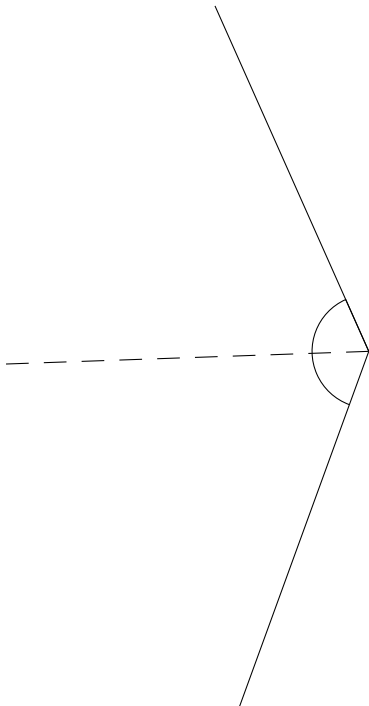

4.

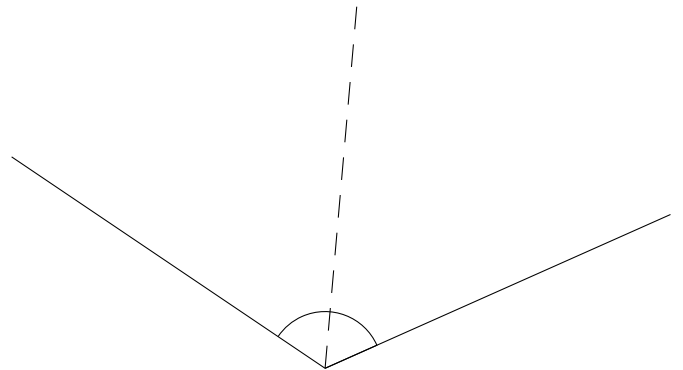



# Bissectrices d'un Angle (I)

Construire la bissectrice pour chaque angle.

1.

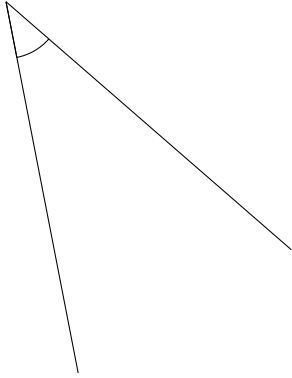

2.

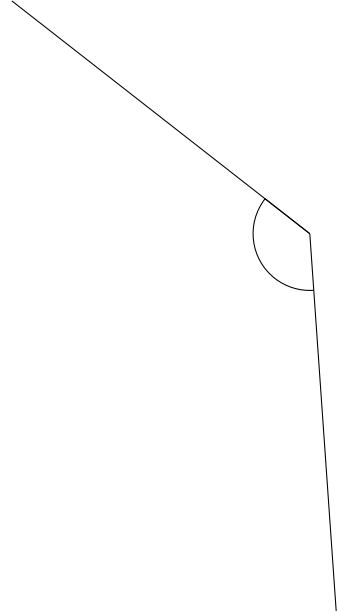

3.

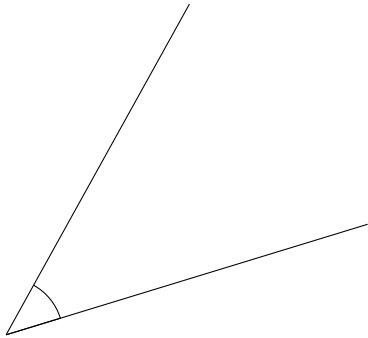

4.

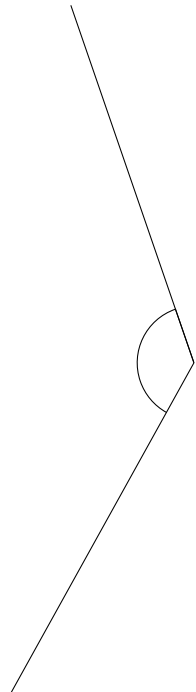

# Bissectrices d'un Angle (I) Solutions

Construire la bissectrice pour chaque angle.

1.

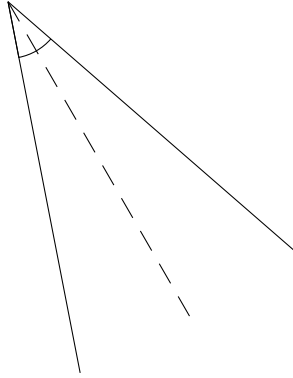

2.

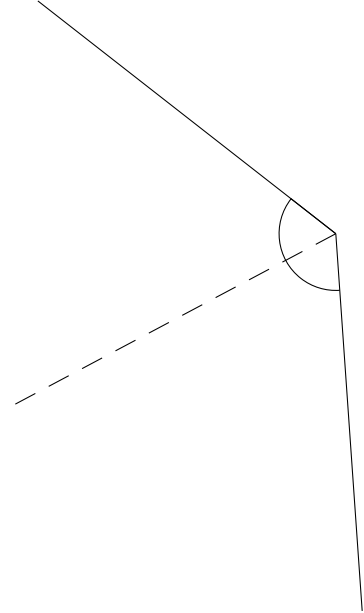

3.

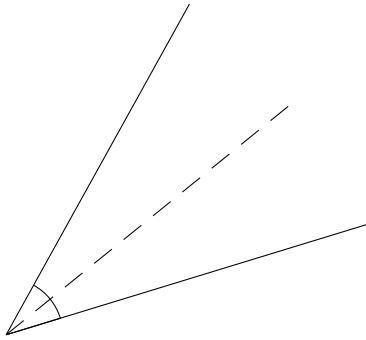

4.

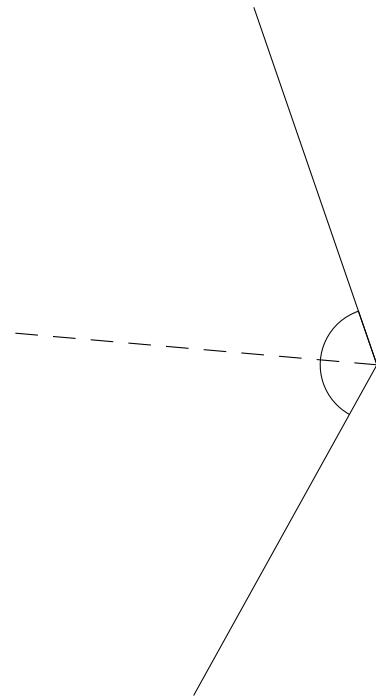

# Bissectrices d'un Angle (J)

Construire la bissectrice pour chaque angle.

1.

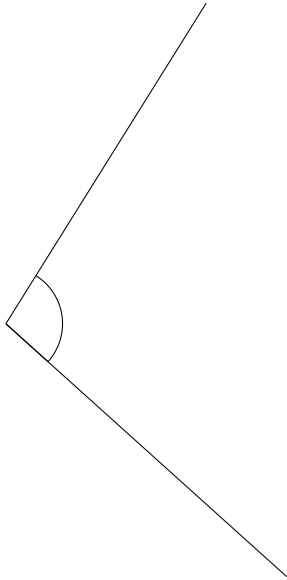

2.

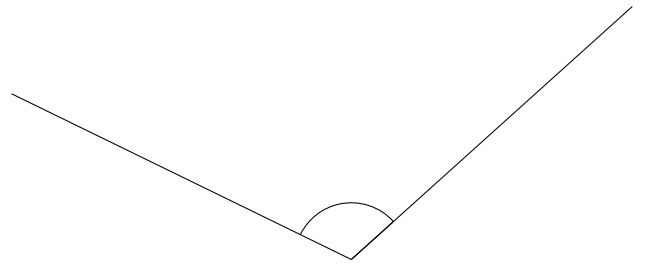

3.

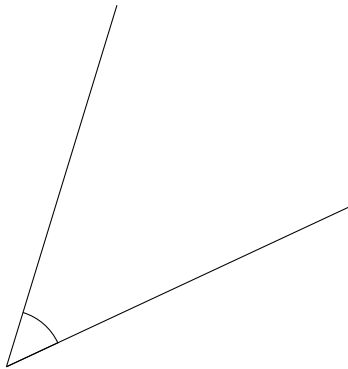

4.

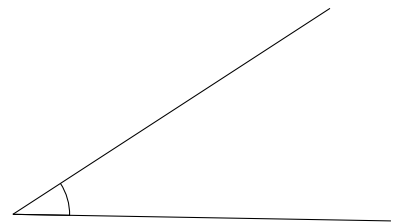

# Bissectrices d'un Angle (J) Solutions

Construire la bissectrice pour chaque angle.

1.

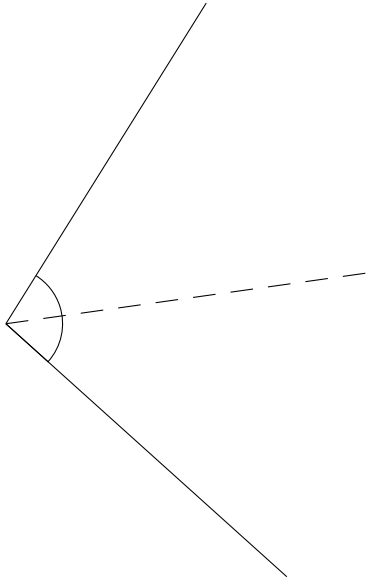

2.

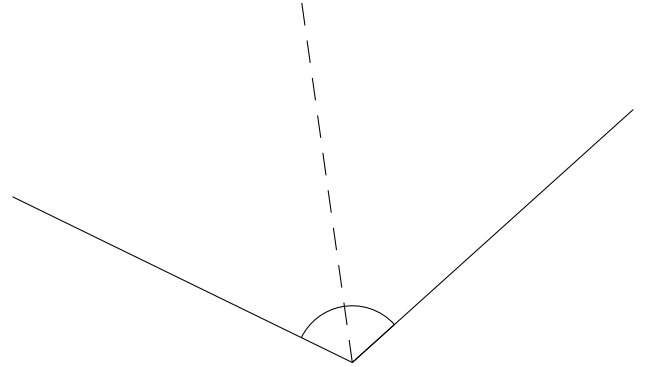

3.

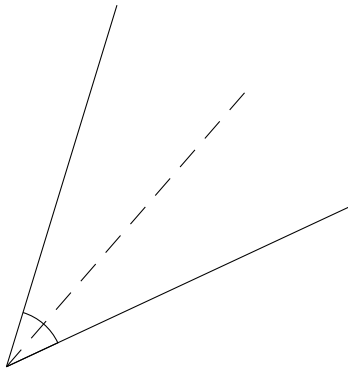

4.

