

Bissectrices d'un Angle (A)

Construire la bissectrice pour chaque angle.

1.

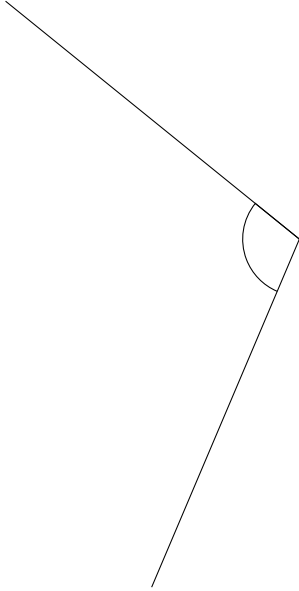

2.

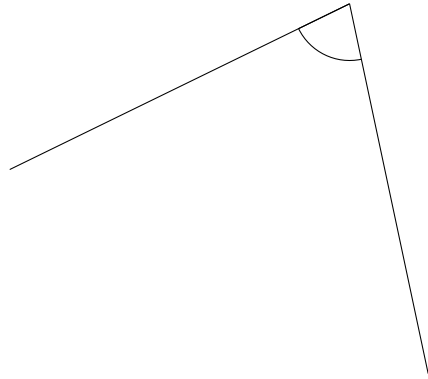

3.

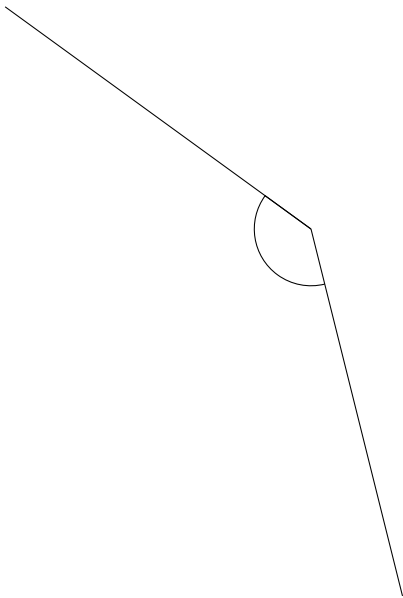

4.

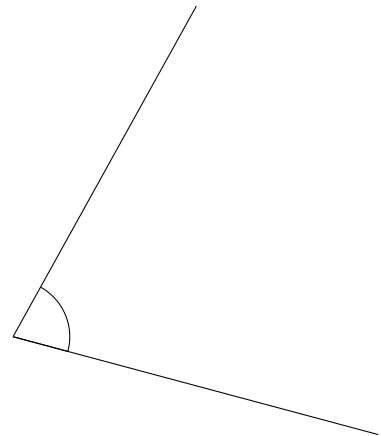

Bissectrices d'un Angle (A) Solutions

Construire la bissectrice pour chaque angle.

1.

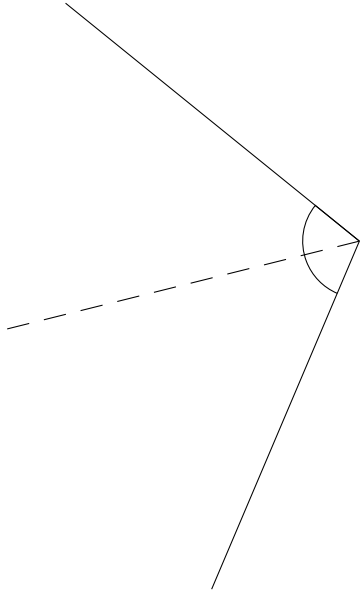

2.

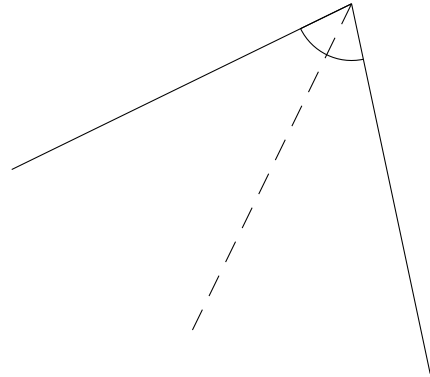

3.

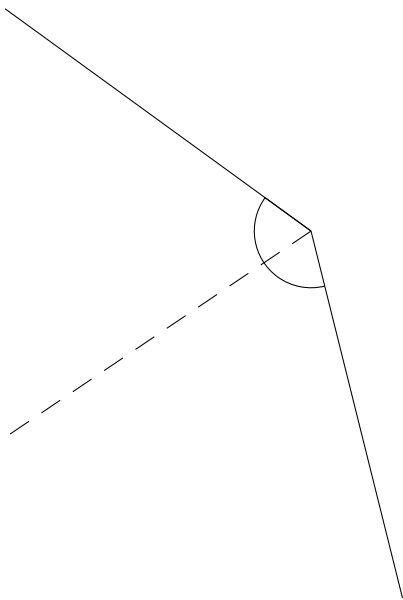

4.

