

# Facteur d'Échelle (A)

Nom: \_\_\_\_\_

Date: \_\_\_\_\_

Déterminez le facteur d'échelle pour chaque paire de figures et marquez les longueurs manquantes.

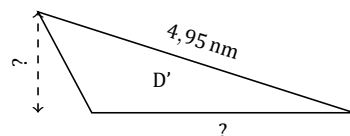
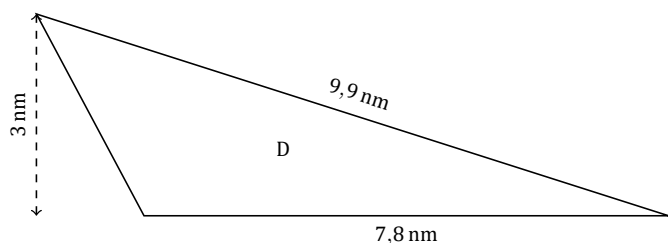
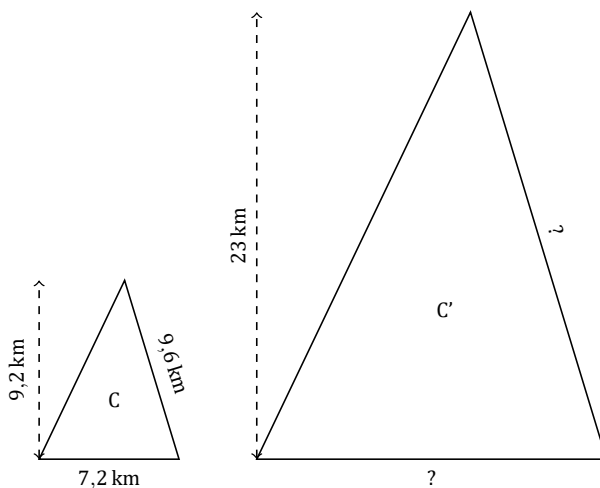
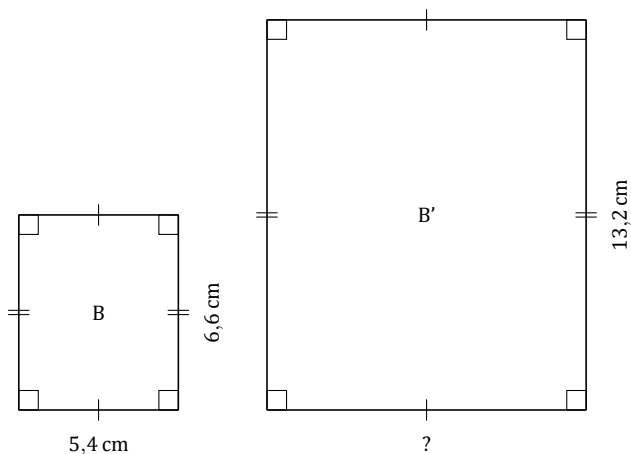
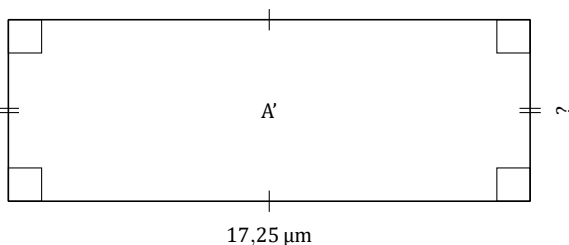
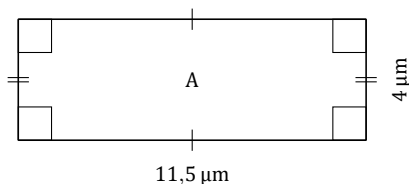

# Facteur d'Échelle (A) Réponses

Nom: \_\_\_\_\_

Date: \_\_\_\_\_

Déterminez le facteur d'échelle pour chaque paire de figures et marquez les longueurs manquantes.

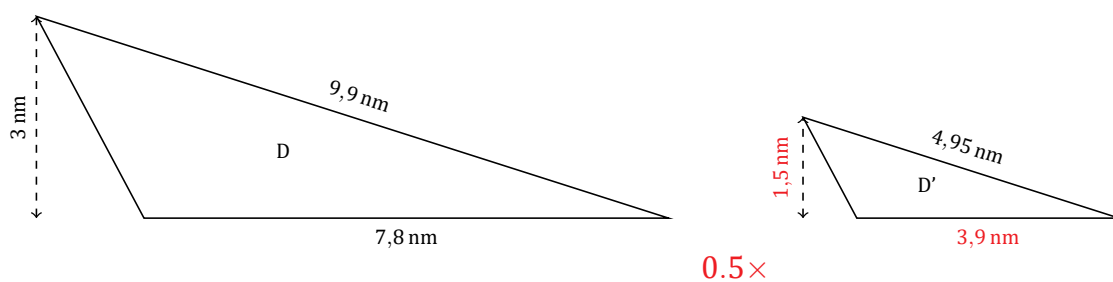
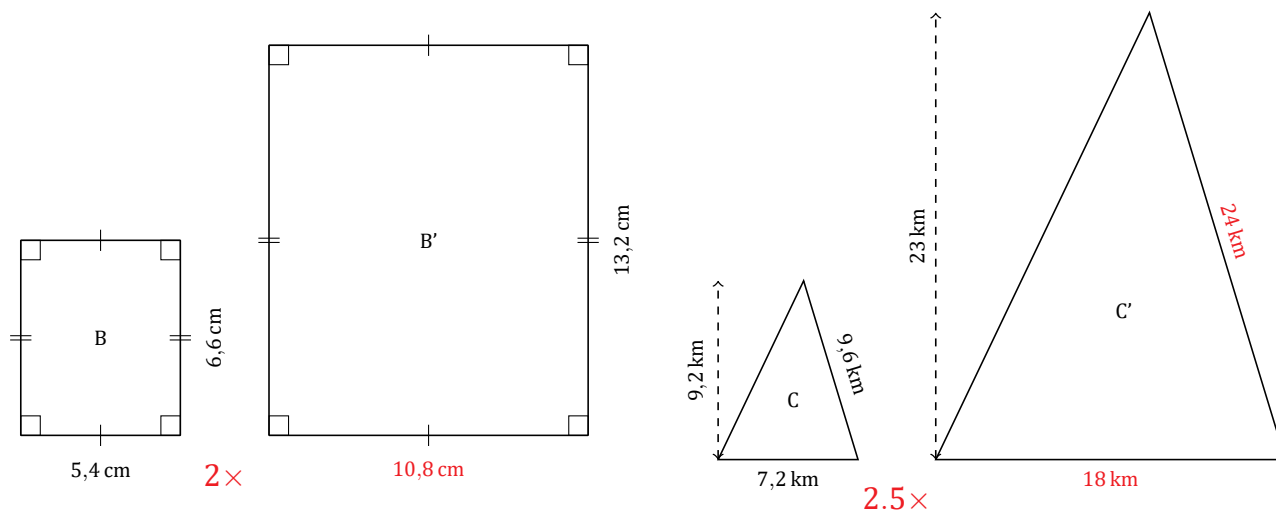
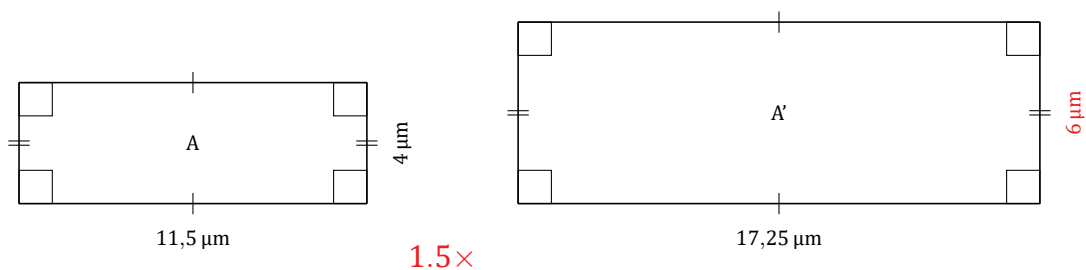

# Facteur d'Échelle (B)

Nom: \_\_\_\_\_

Date: \_\_\_\_\_

Déterminez le facteur d'échelle pour chaque paire de figures et marquez les longueurs manquantes.

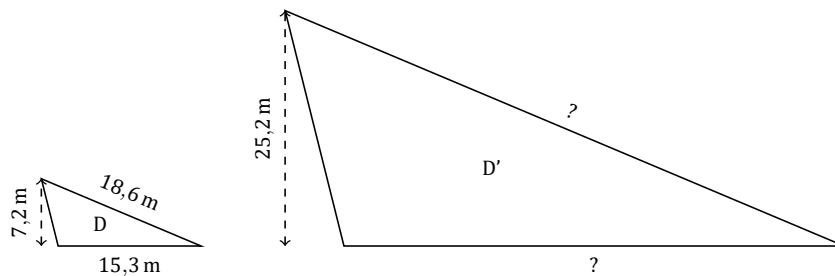
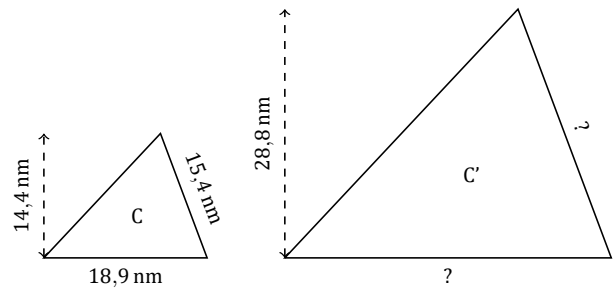
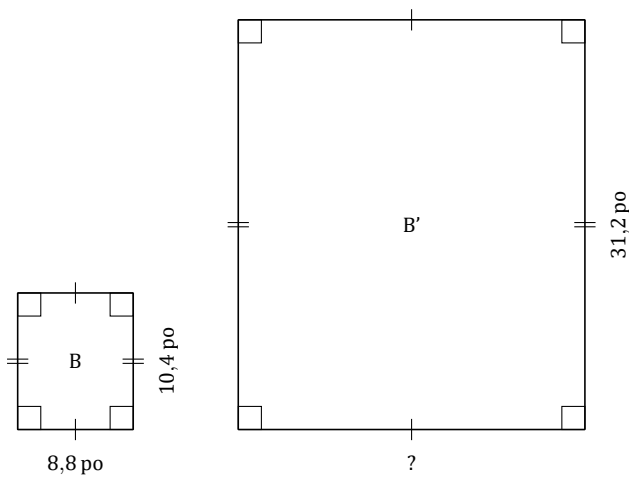
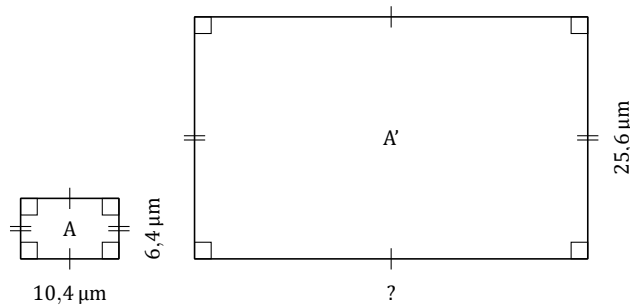

# Facteur d'Échelle (B) Réponses

Nom: \_\_\_\_\_

Date: \_\_\_\_\_

Déterminez le facteur d'échelle pour chaque paire de figures et marquez les longueurs manquantes.

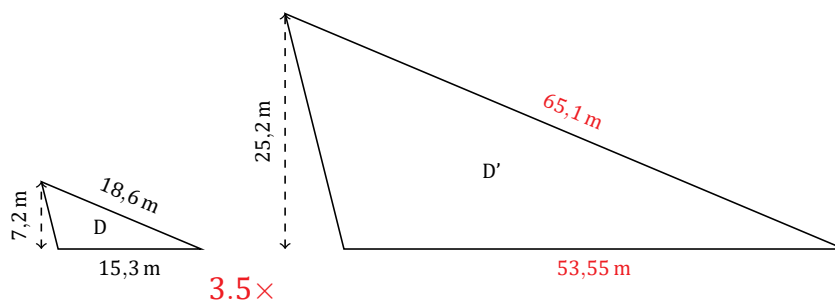
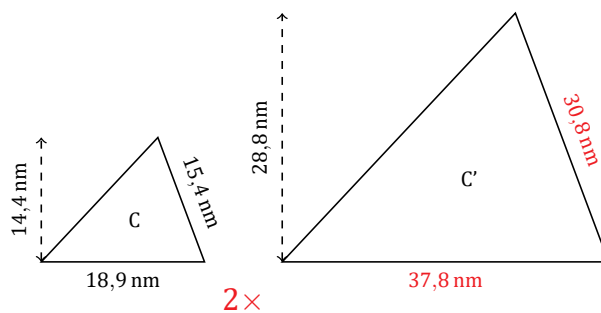
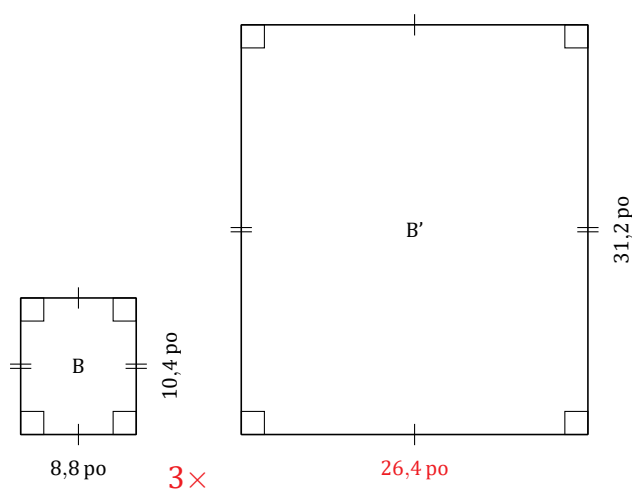
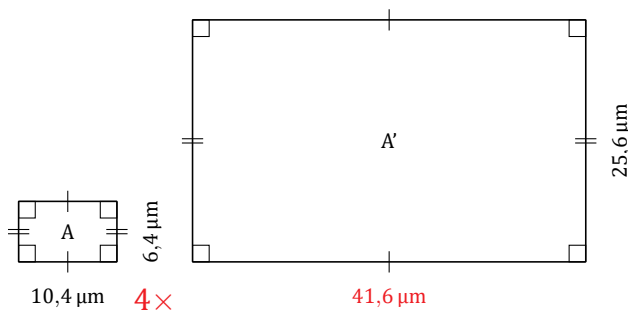

# Facteur d'Échelle (C)

Nom: \_\_\_\_\_

Date: \_\_\_\_\_

Déterminez le facteur d'échelle pour chaque paire de figures et marquez les longueurs manquantes.

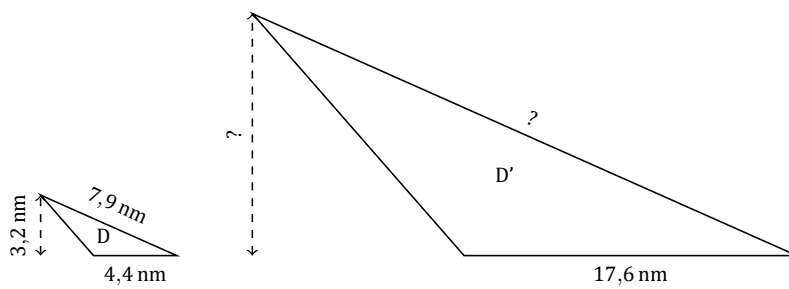
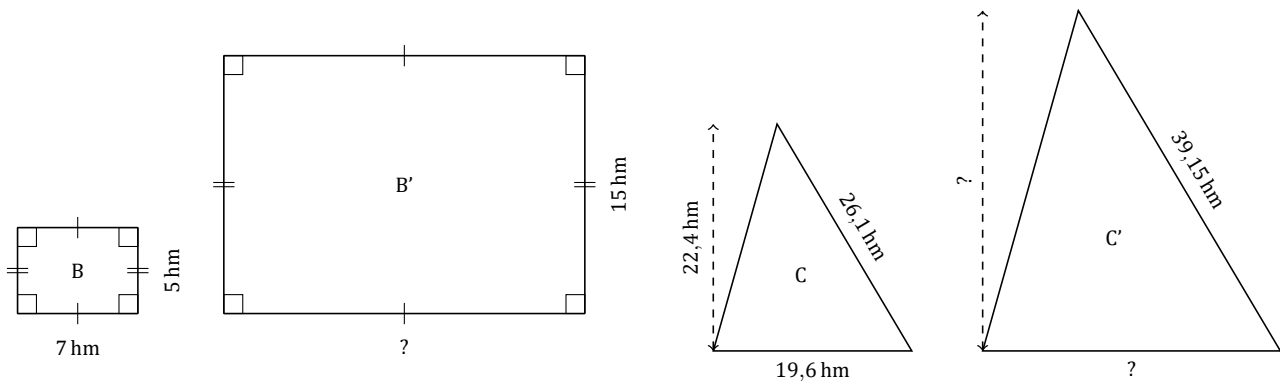
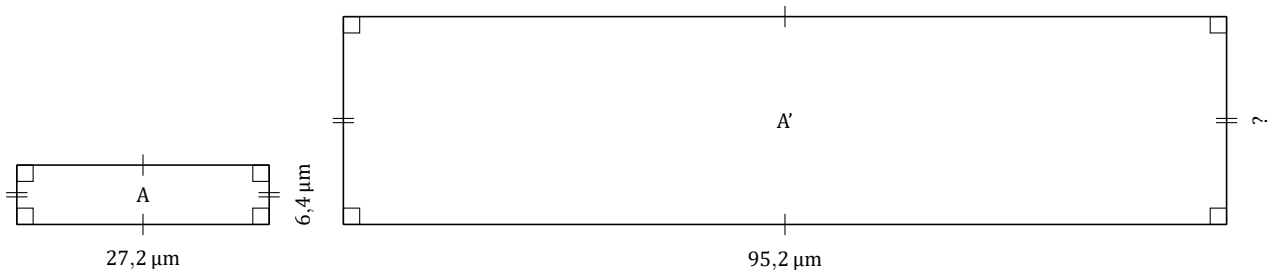

# Facteur d'Échelle (C) Réponses

Nom: \_\_\_\_\_

Date: \_\_\_\_\_

Déterminez le facteur d'échelle pour chaque paire de figures et marquez les longueurs manquantes.

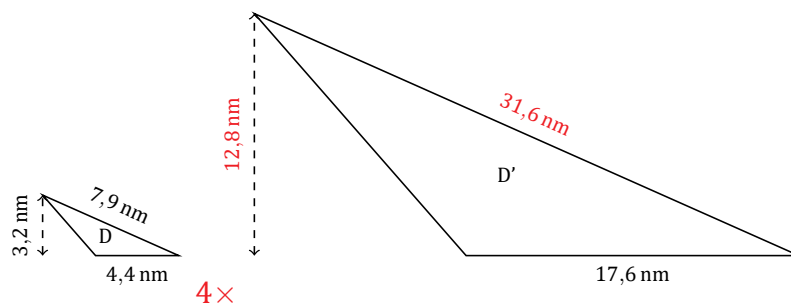
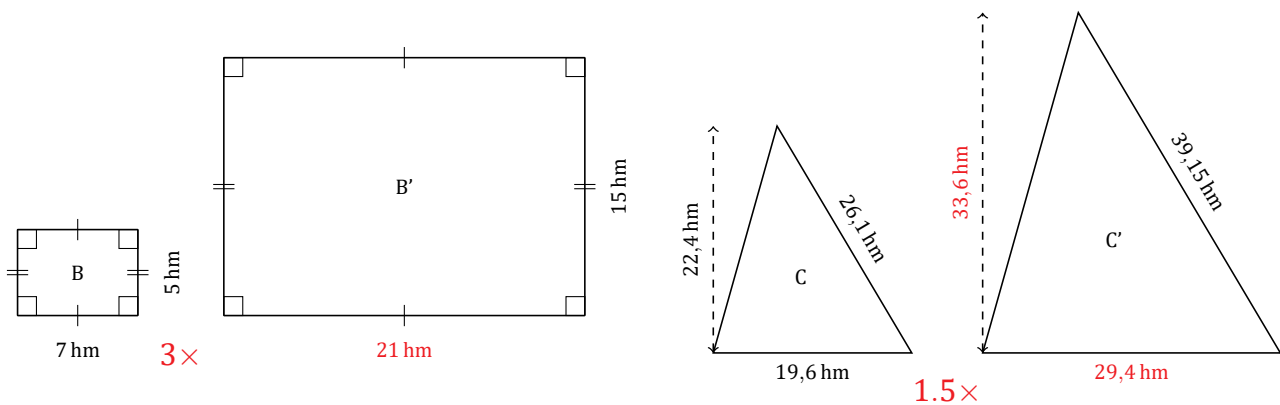
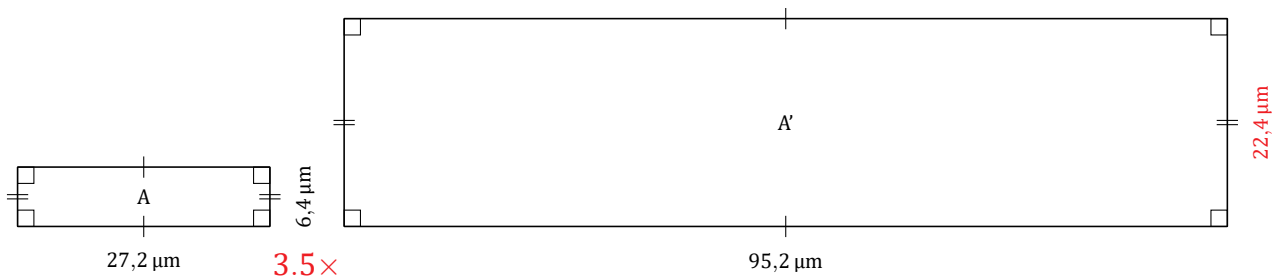

# Facteur d'Échelle (D)

Nom: \_\_\_\_\_

Date: \_\_\_\_\_

Déterminez le facteur d'échelle pour chaque paire de figures et marquez les longueurs manquantes.

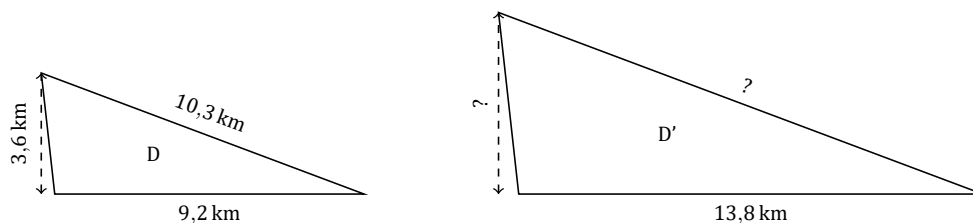
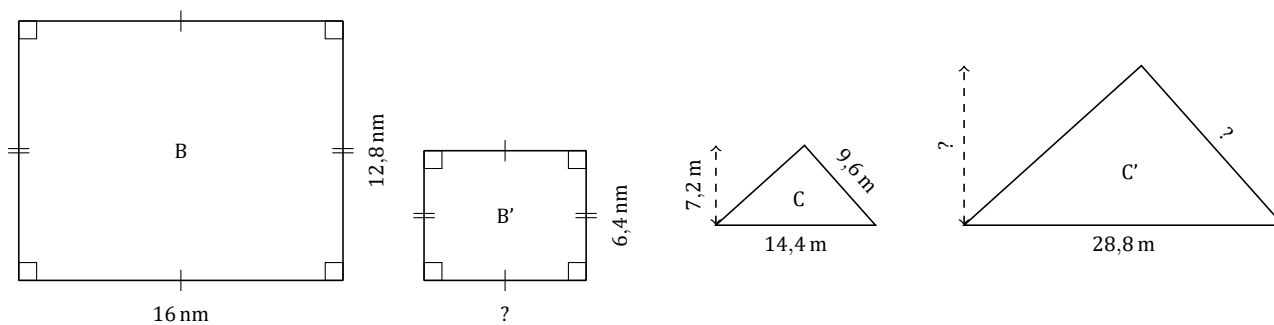
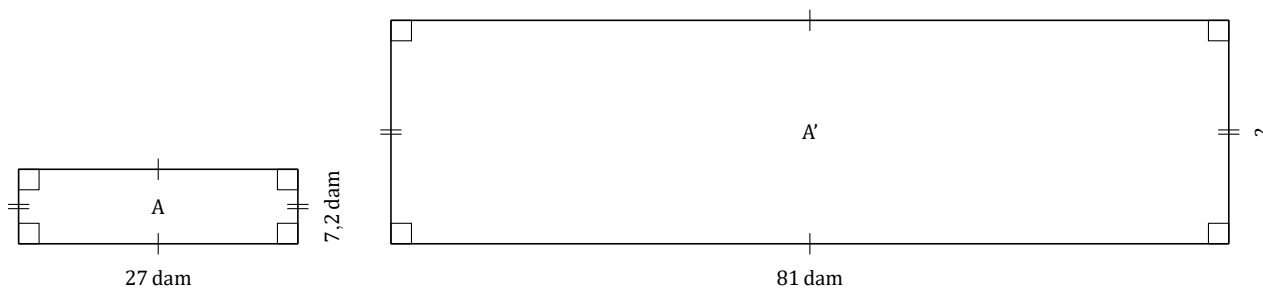

# Facteur d'Échelle (D) Réponses

Nom: \_\_\_\_\_

Date: \_\_\_\_\_

Déterminez le facteur d'échelle pour chaque paire de figures et marquez les longueurs manquantes.

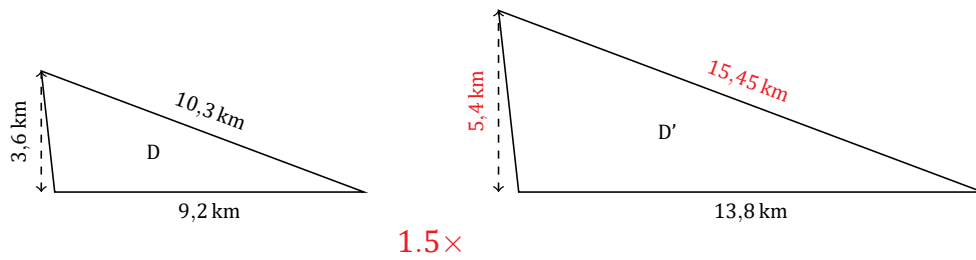
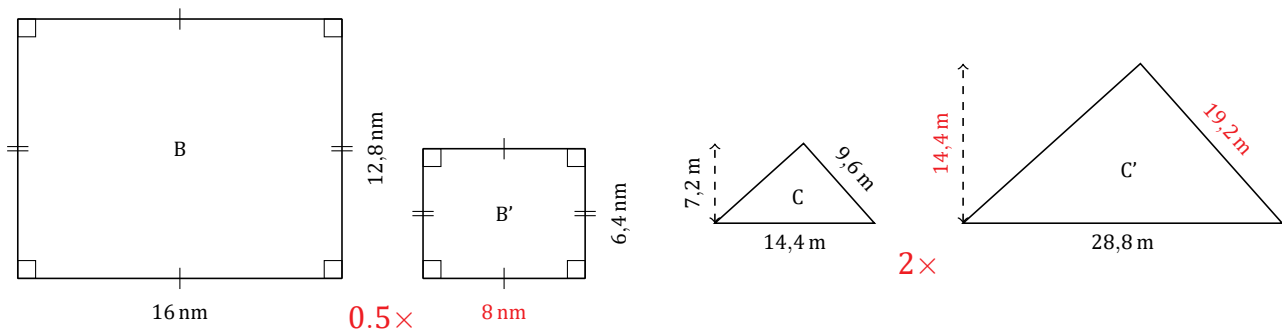
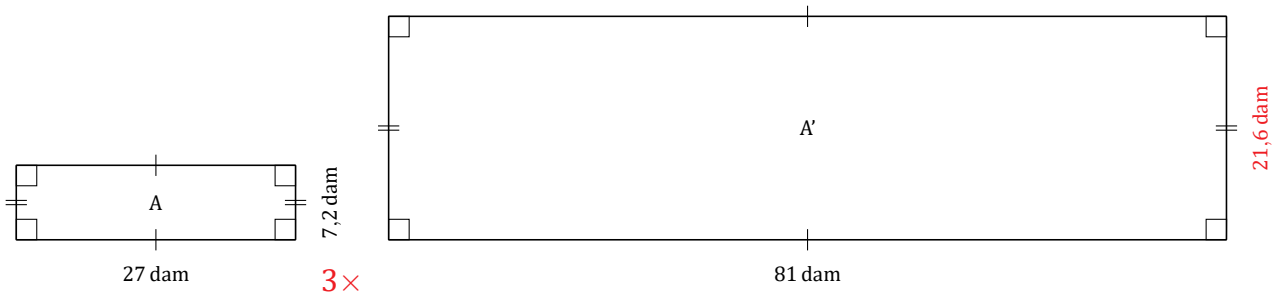



# Facteur d'Échelle (E)

Nom: \_\_\_\_\_

Date: \_\_\_\_\_

Déterminez le facteur d'échelle pour chaque paire de figures et marquez les longueurs manquantes.

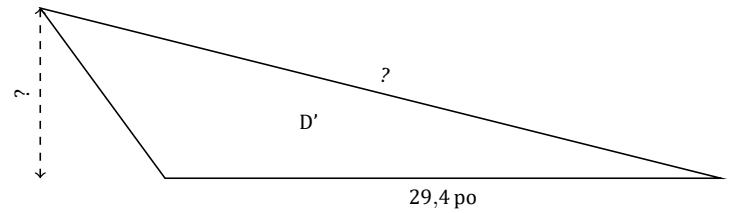
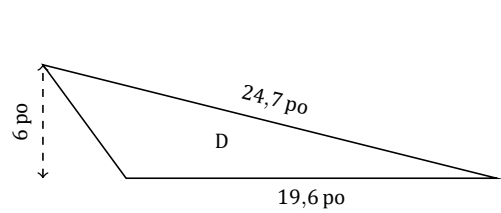
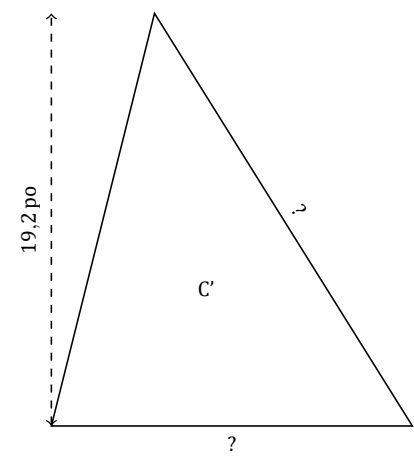
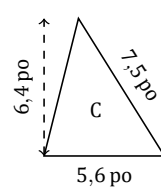
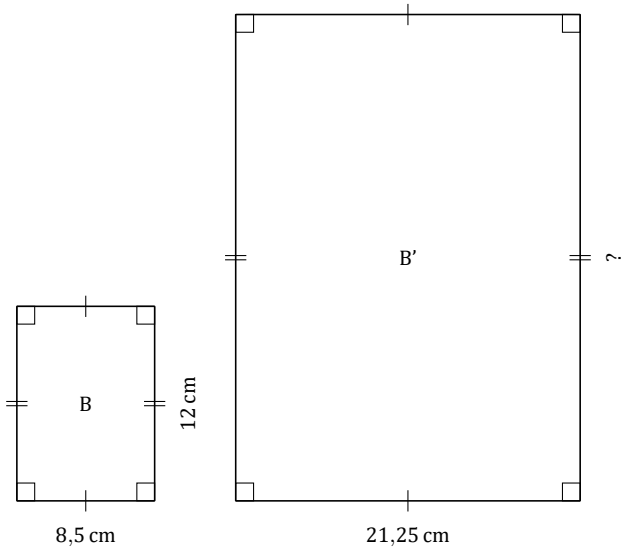
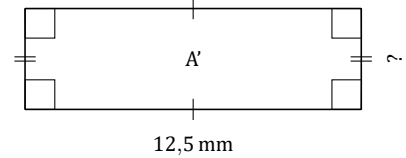
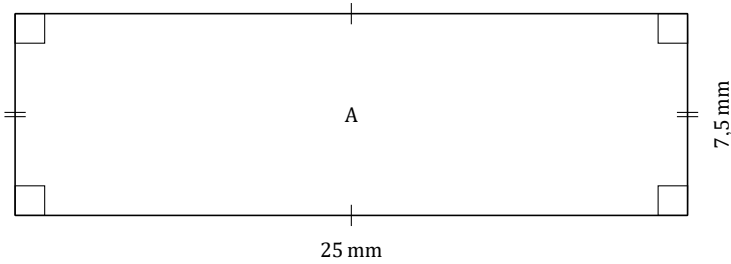

# Facteur d'Échelle (E) Réponses

Nom: \_\_\_\_\_

Date: \_\_\_\_\_

Déterminez le facteur d'échelle pour chaque paire de figures et marquez les longueurs manquantes.

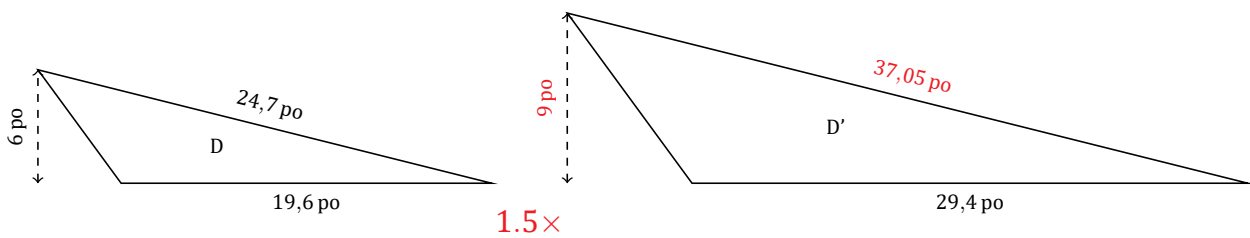
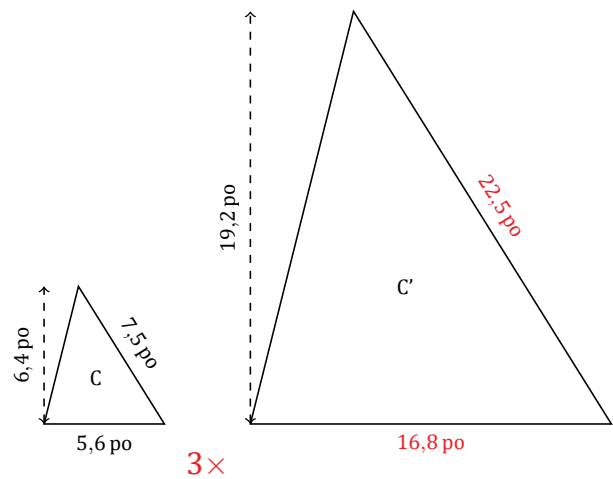
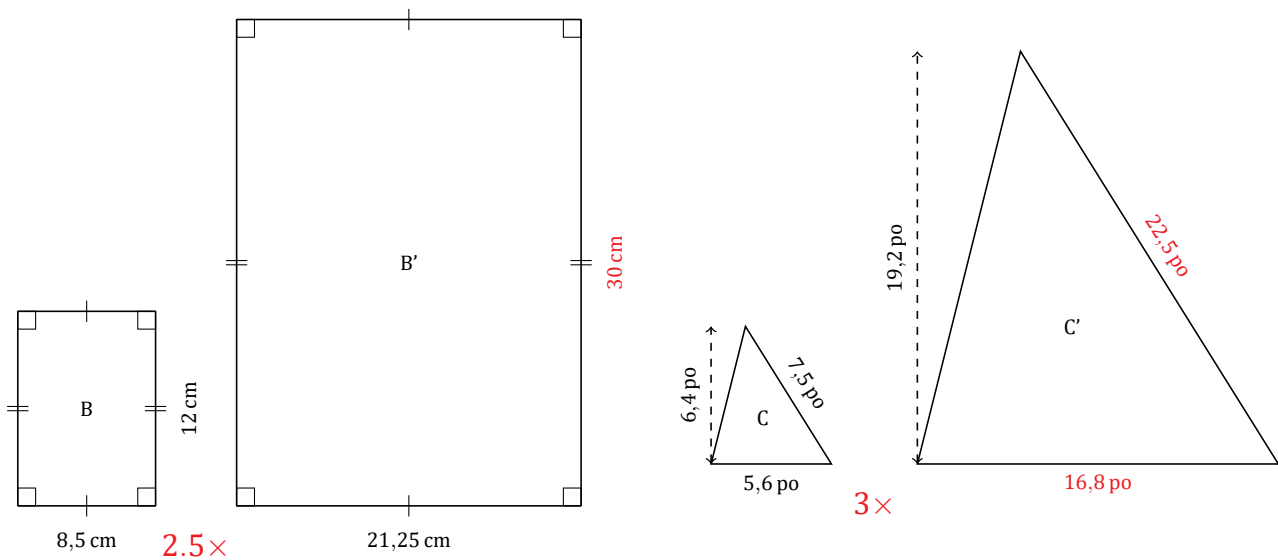
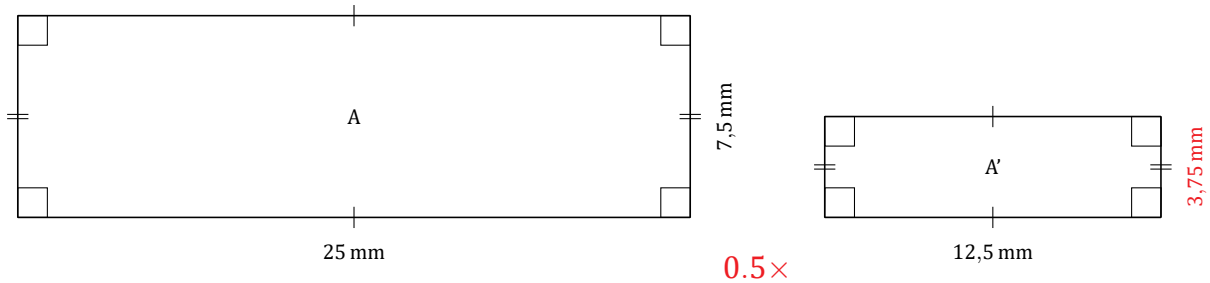

# Facteur d'Échelle (F)

Nom: \_\_\_\_\_

Date: \_\_\_\_\_

Déterminez le facteur d'échelle pour chaque paire de figures et marquez les longueurs manquantes.

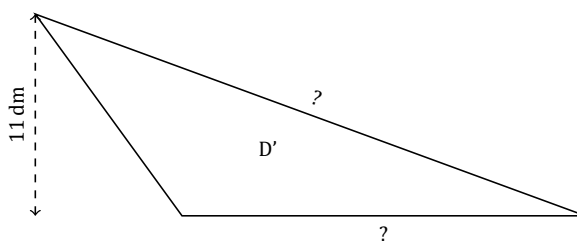
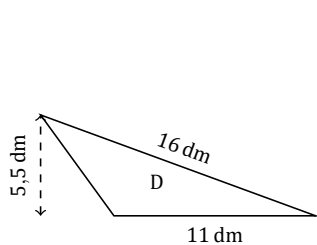
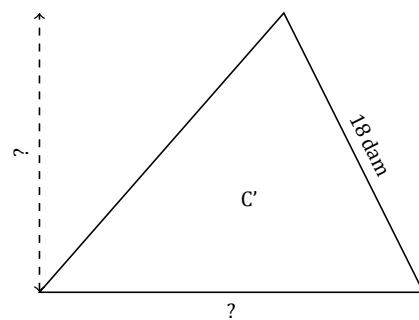
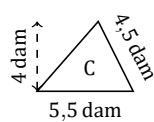
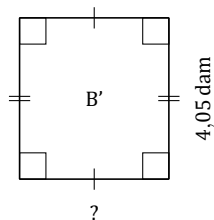
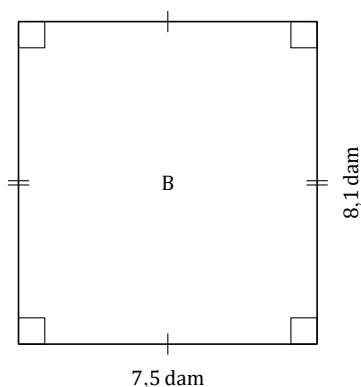
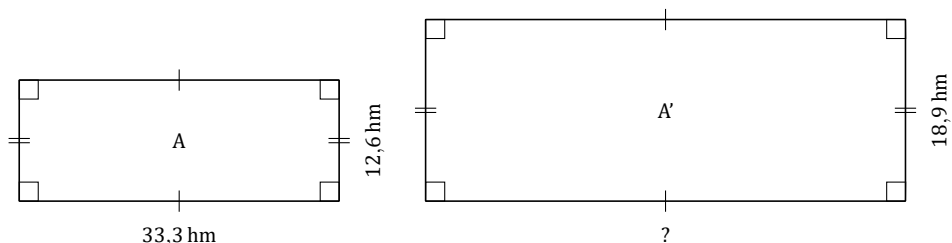

# Facteur d'Échelle (F) Réponses

Nom: \_\_\_\_\_

Date: \_\_\_\_\_

Déterminez le facteur d'échelle pour chaque paire de figures et marquez les longueurs manquantes.

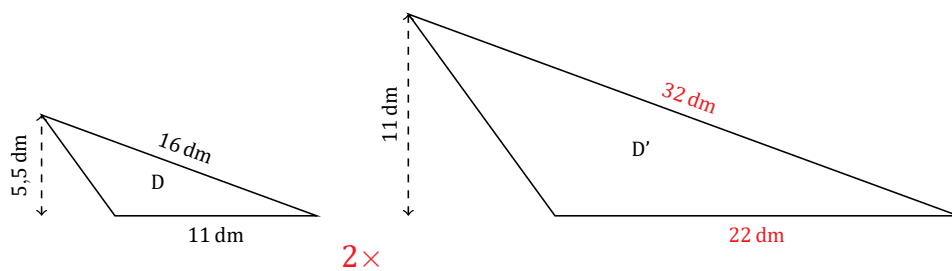
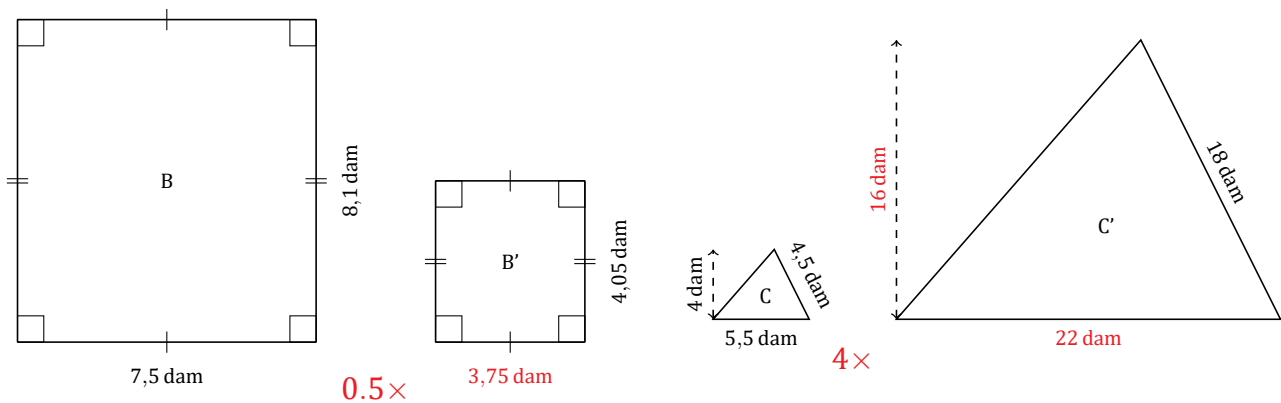
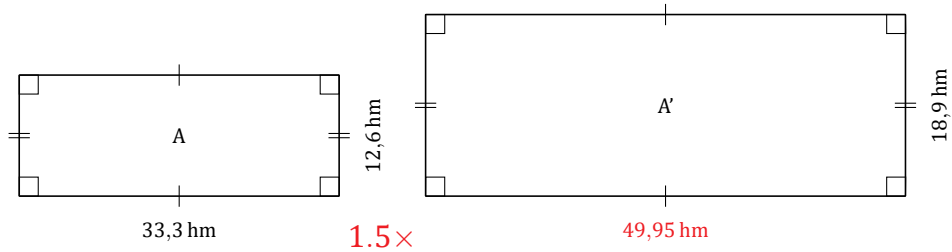

# Facteur d'Échelle (G)

Nom: \_\_\_\_\_

Date: \_\_\_\_\_

Déterminez le facteur d'échelle pour chaque paire de figures et marquez les longueurs manquantes.

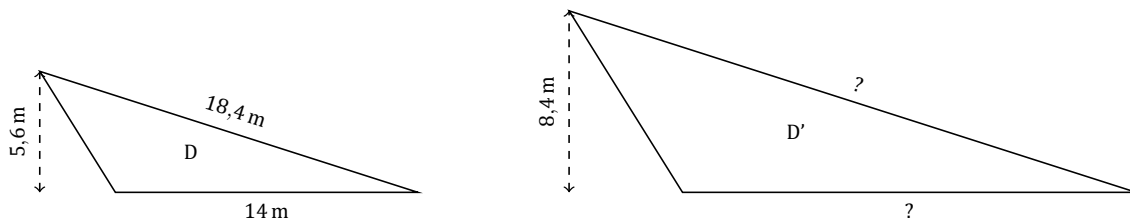
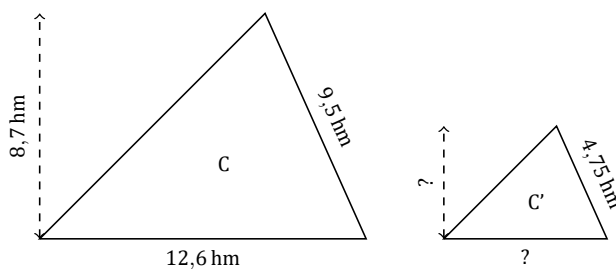
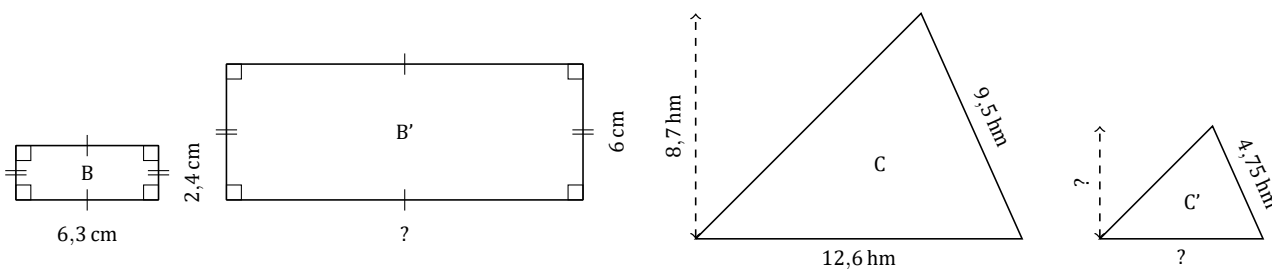
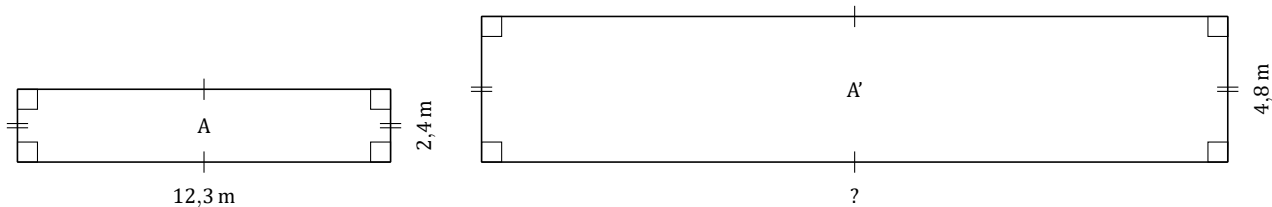

# Facteur d'Échelle (G) Réponses

Nom: \_\_\_\_\_

Date: \_\_\_\_\_

Déterminez le facteur d'échelle pour chaque paire de figures et marquez les longueurs manquantes.

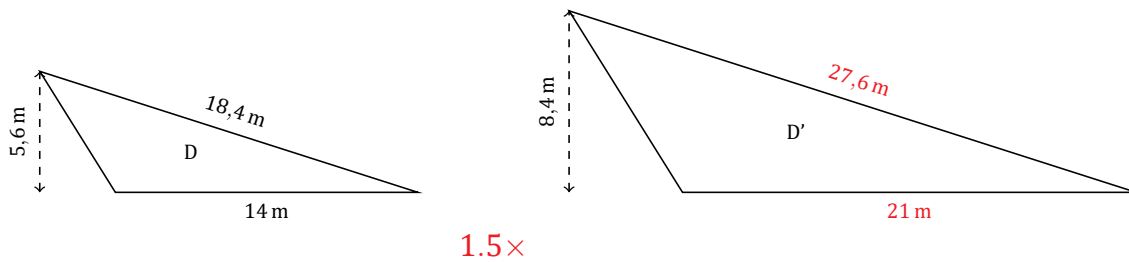
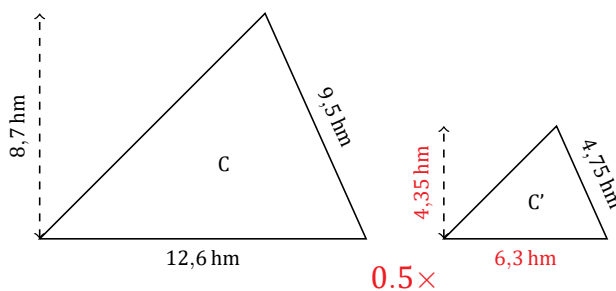
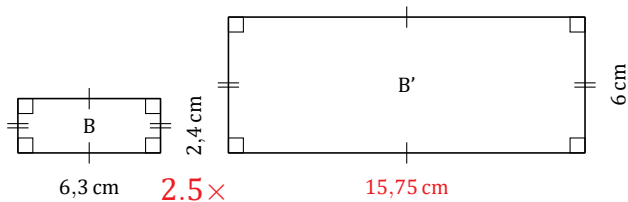
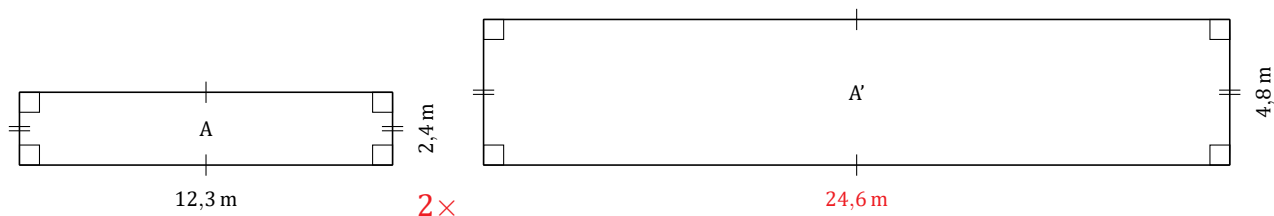

# Facteur d'Échelle (H)

Nom: \_\_\_\_\_

Date: \_\_\_\_\_

Déterminez le facteur d'échelle pour chaque paire de figures et marquez les longueurs manquantes.

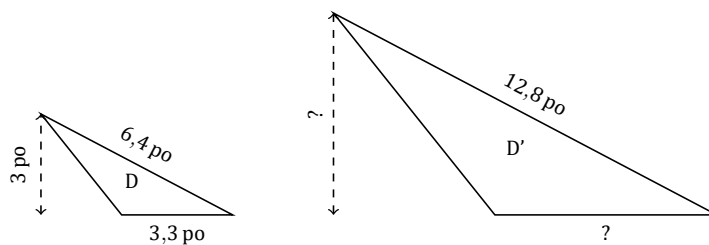
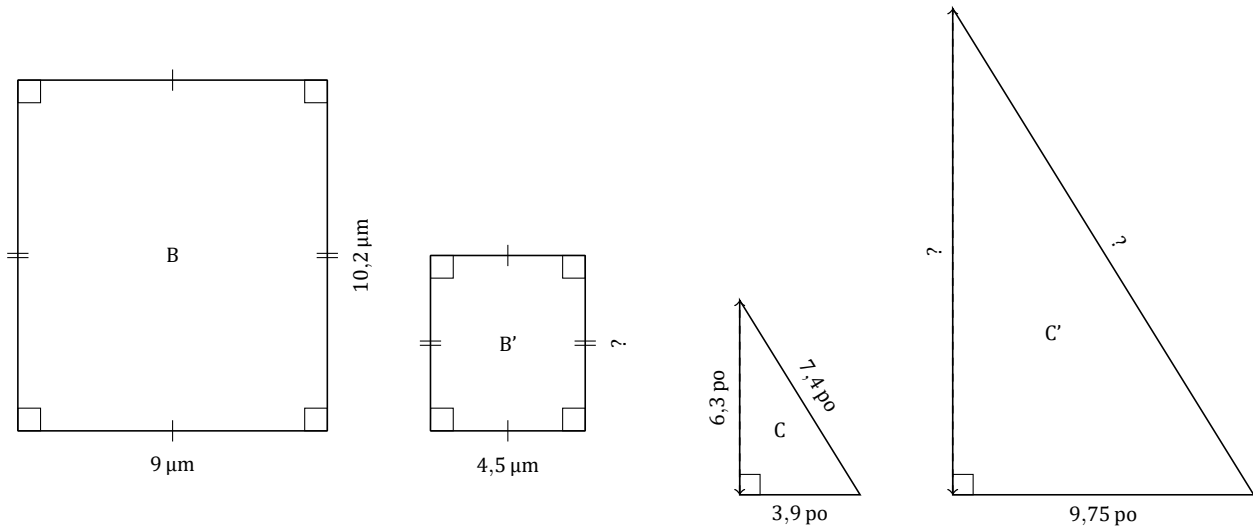
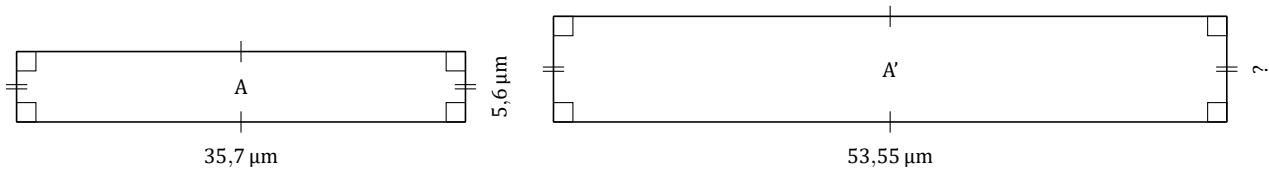

# Facteur d'Échelle (H) Réponses

Nom: \_\_\_\_\_

Date: \_\_\_\_\_

Déterminez le facteur d'échelle pour chaque paire de figures et marquez les longueurs manquantes.

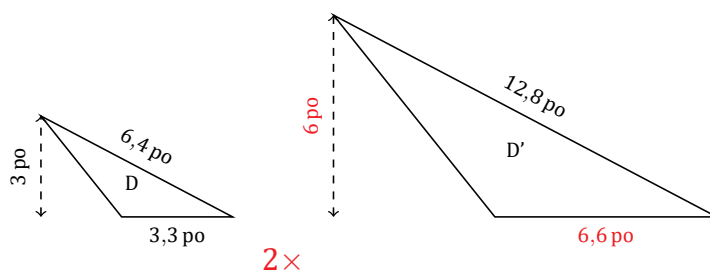
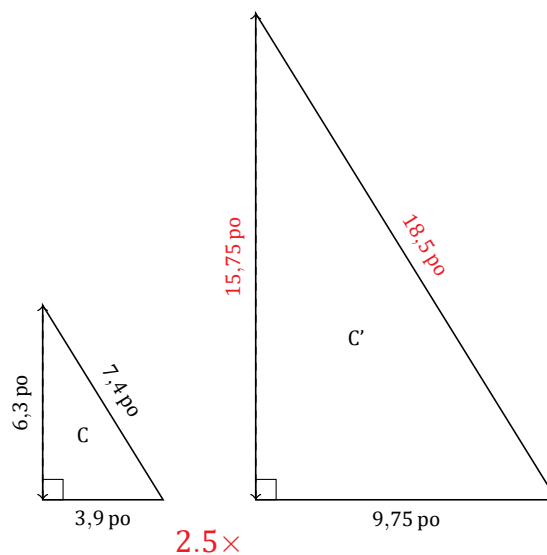
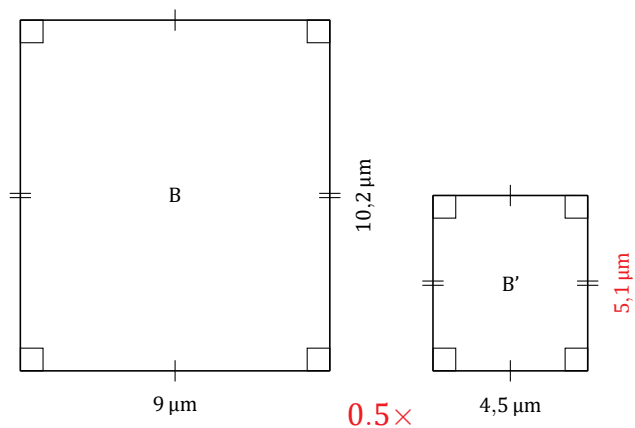
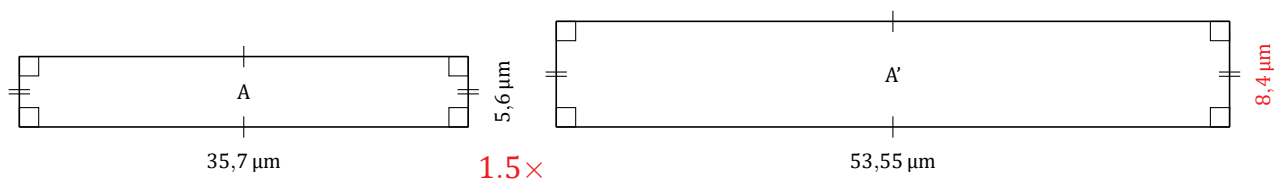



# Facteur d'Échelle (I)

Nom: \_\_\_\_\_

Date: \_\_\_\_\_

Déterminez le facteur d'échelle pour chaque paire de figures et marquez les longueurs manquantes.

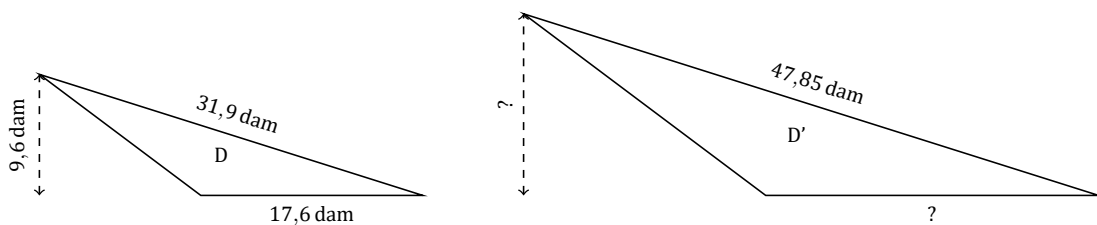
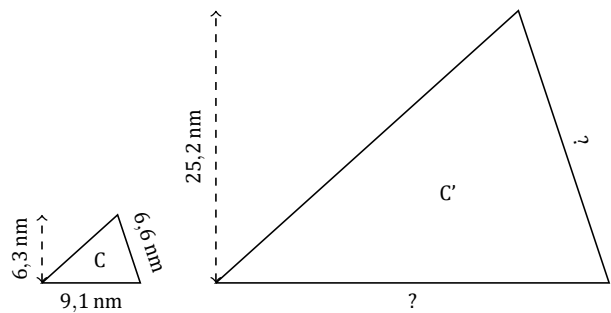
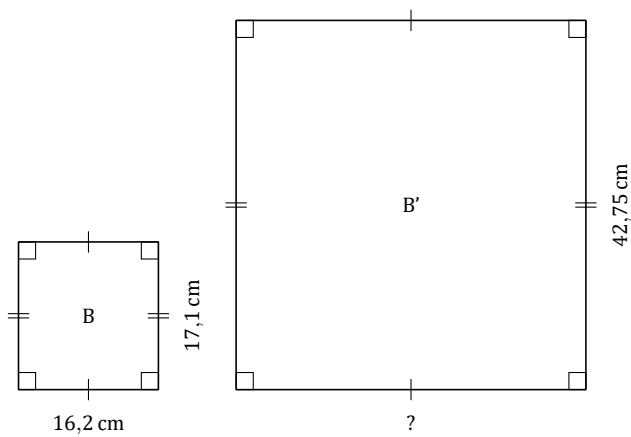
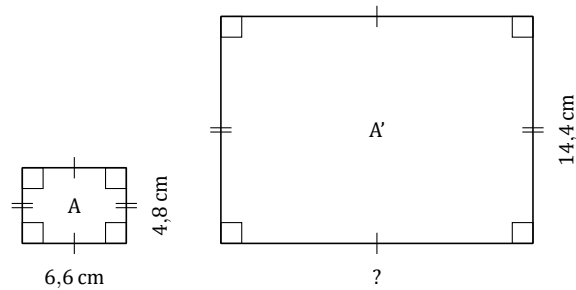

# Facteur d'Échelle (I) Réponses

Nom: \_\_\_\_\_

Date: \_\_\_\_\_

Déterminez le facteur d'échelle pour chaque paire de figures et marquez les longueurs manquantes.

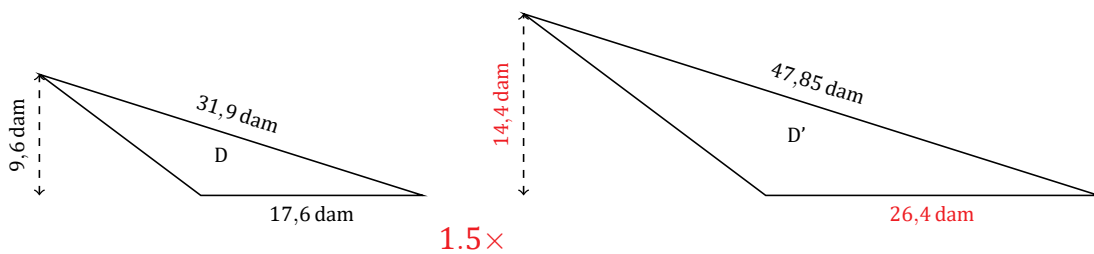
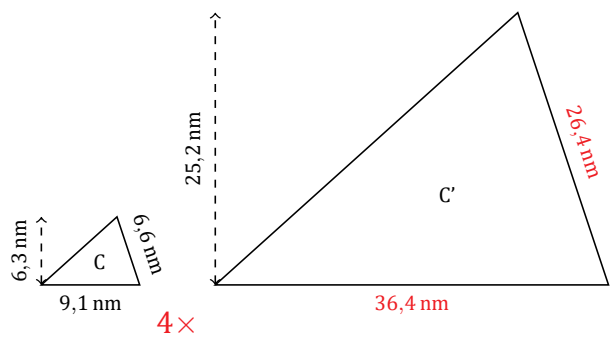
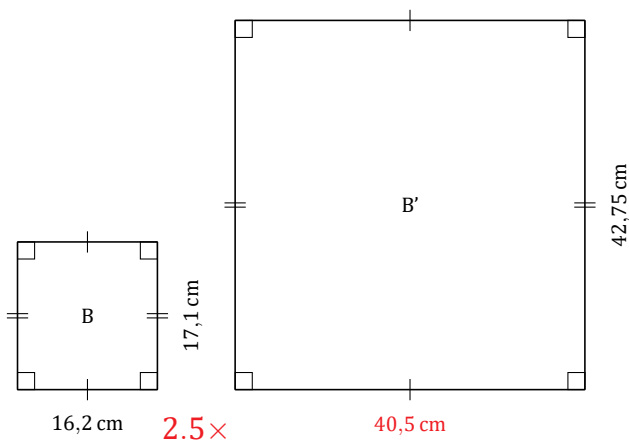
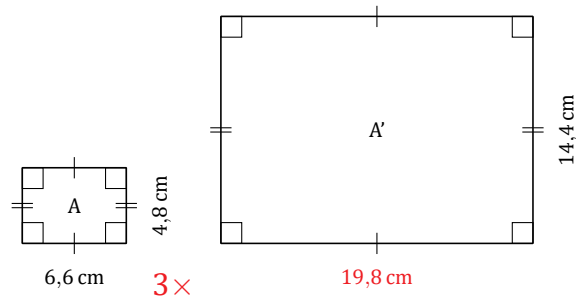

# Facteur d'Échelle (J)

Nom: \_\_\_\_\_

Date: \_\_\_\_\_

Déterminez le facteur d'échelle pour chaque paire de figures et marquez les longueurs manquantes.

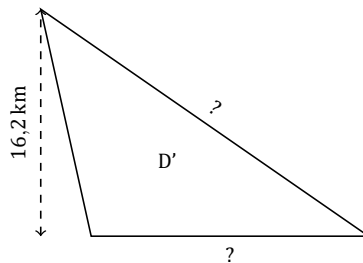
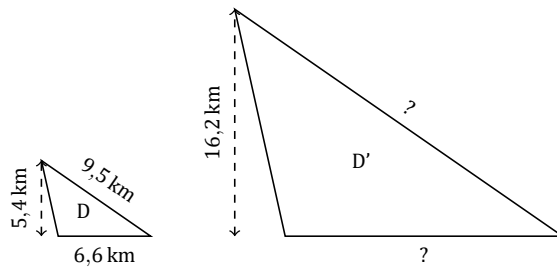
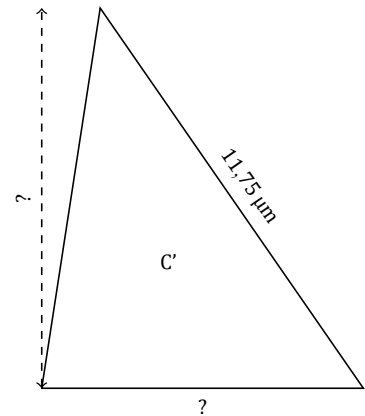
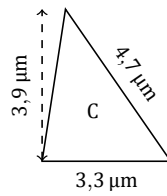
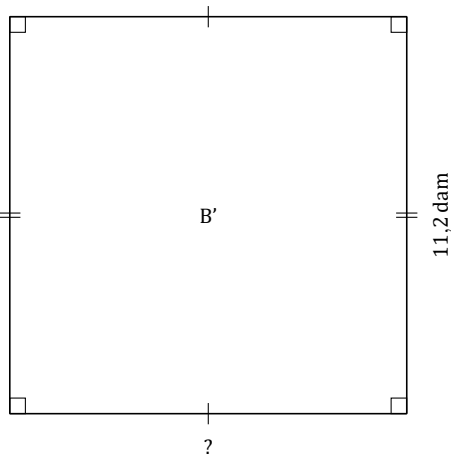
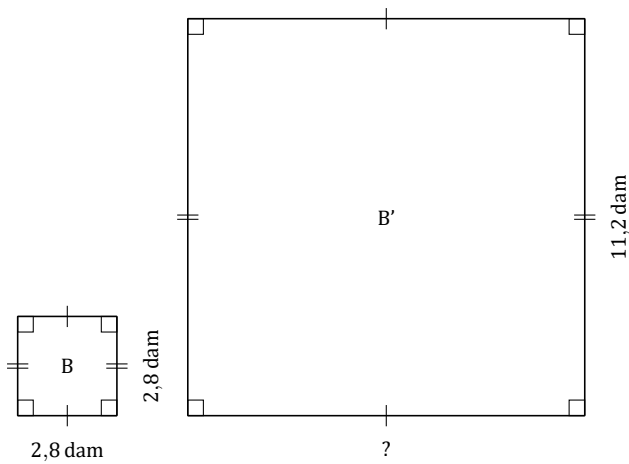
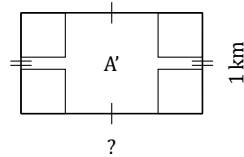
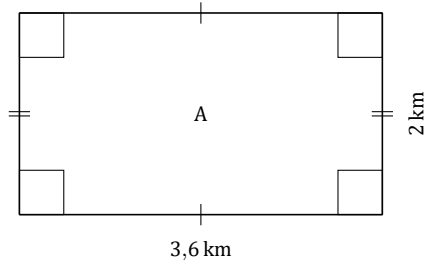

# Facteur d'Échelle (J) Réponses

Nom: \_\_\_\_\_

Date: \_\_\_\_\_

Déterminez le facteur d'échelle pour chaque paire de figures et marquez les longueurs manquantes.

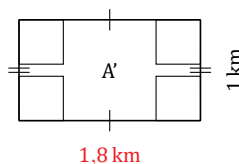
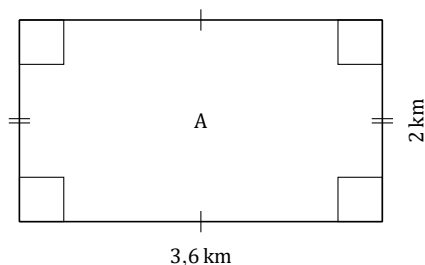

0.5×

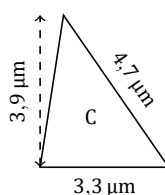
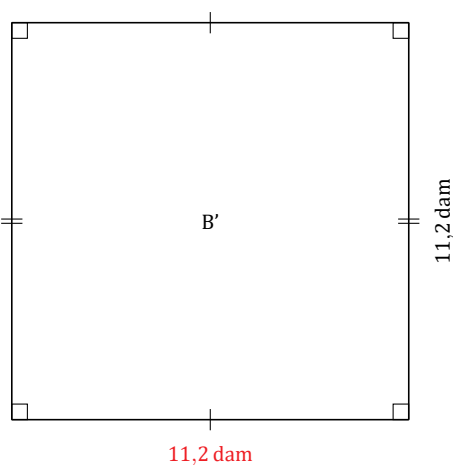
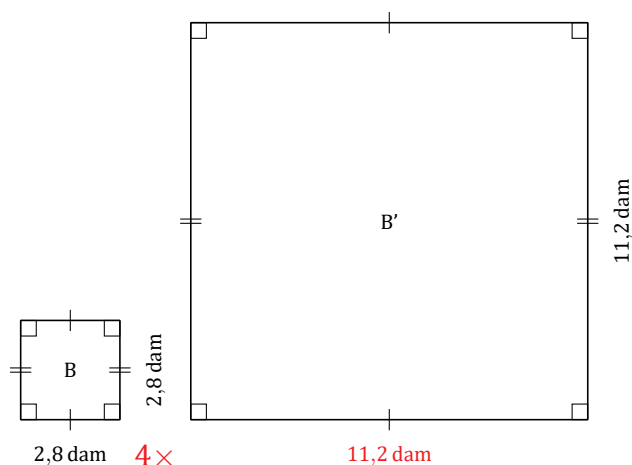

2.5×

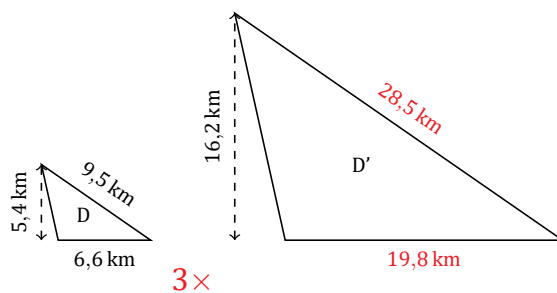
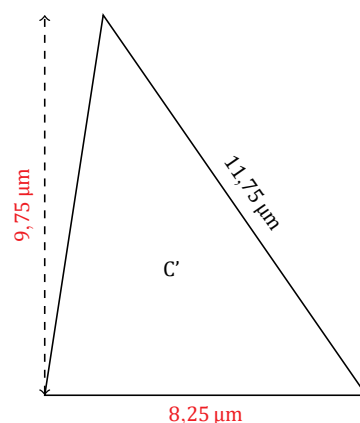

3×

