

Médiatrice d'un Segment (A)

Nom: _____

Date: _____

Construisez la médiatrice à l'aide d'une règle et un compas.

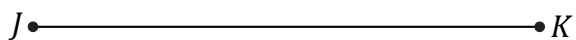
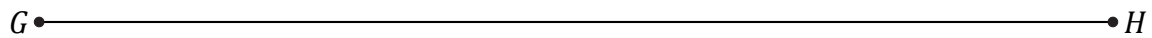
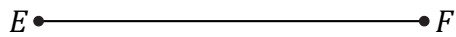
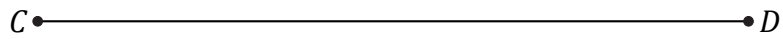
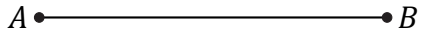

Médiatrice d'un Segment (A) Réponses

Nom: _____

Date: _____

Construisez la médiatrice à l'aide d'une règle et un compas.

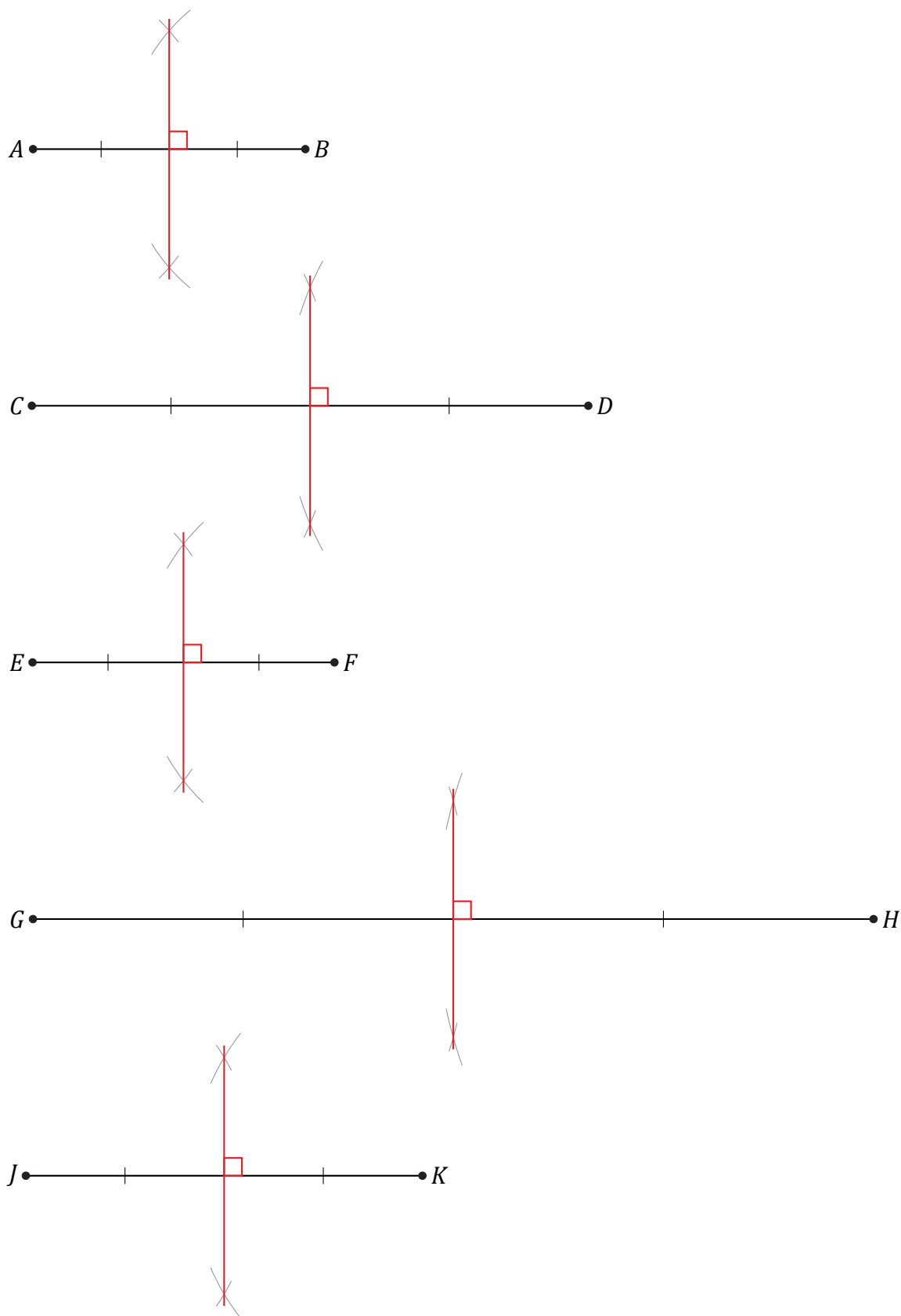

Médiatrice d'un Segment (B)

Nom: _____

Date: _____

Construisez la médiatrice à l'aide d'une règle et un compas.

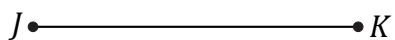
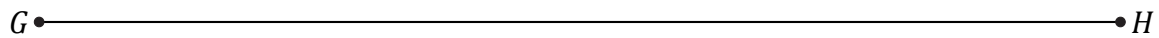
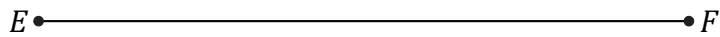
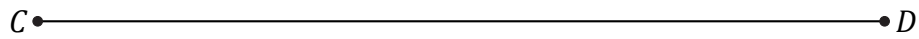

Médiatrice d'un Segment (B) Réponses

Nom: _____

Date: _____

Construisez la médiatrice à l'aide d'une règle et un compas.

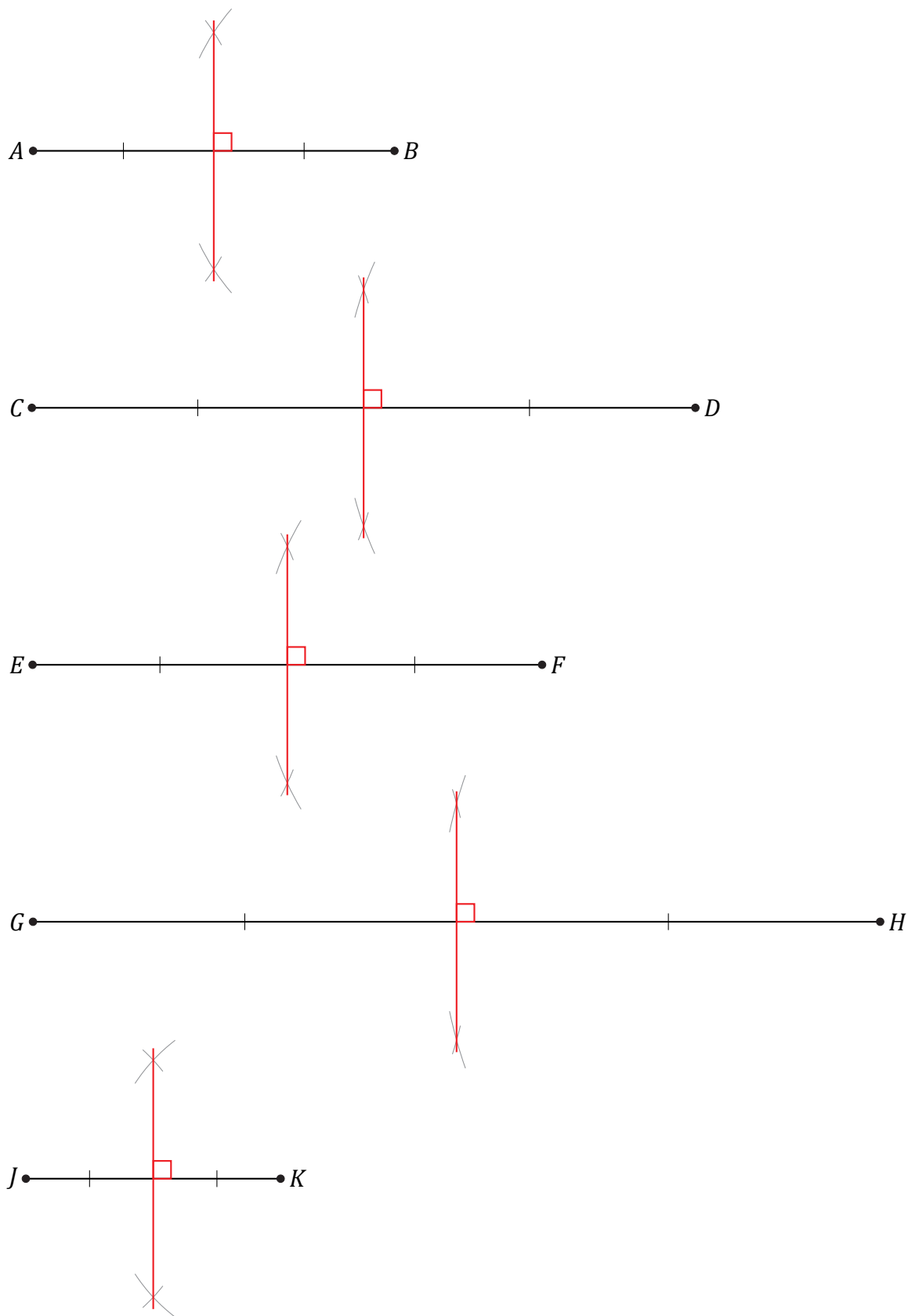

Médiatrice d'un Segment (C)

Nom: _____

Date: _____

Construisez la médiatrice à l'aide d'une règle et un compas.

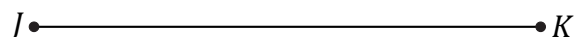
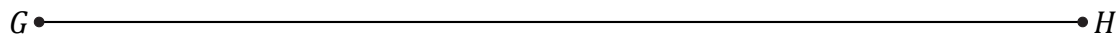
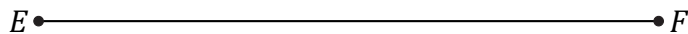
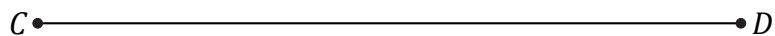
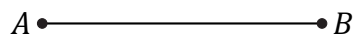

Médiatrice d'un Segment (C) Réponses

Nom: _____

Date: _____

Construisez la médiatrice à l'aide d'une règle et un compas.

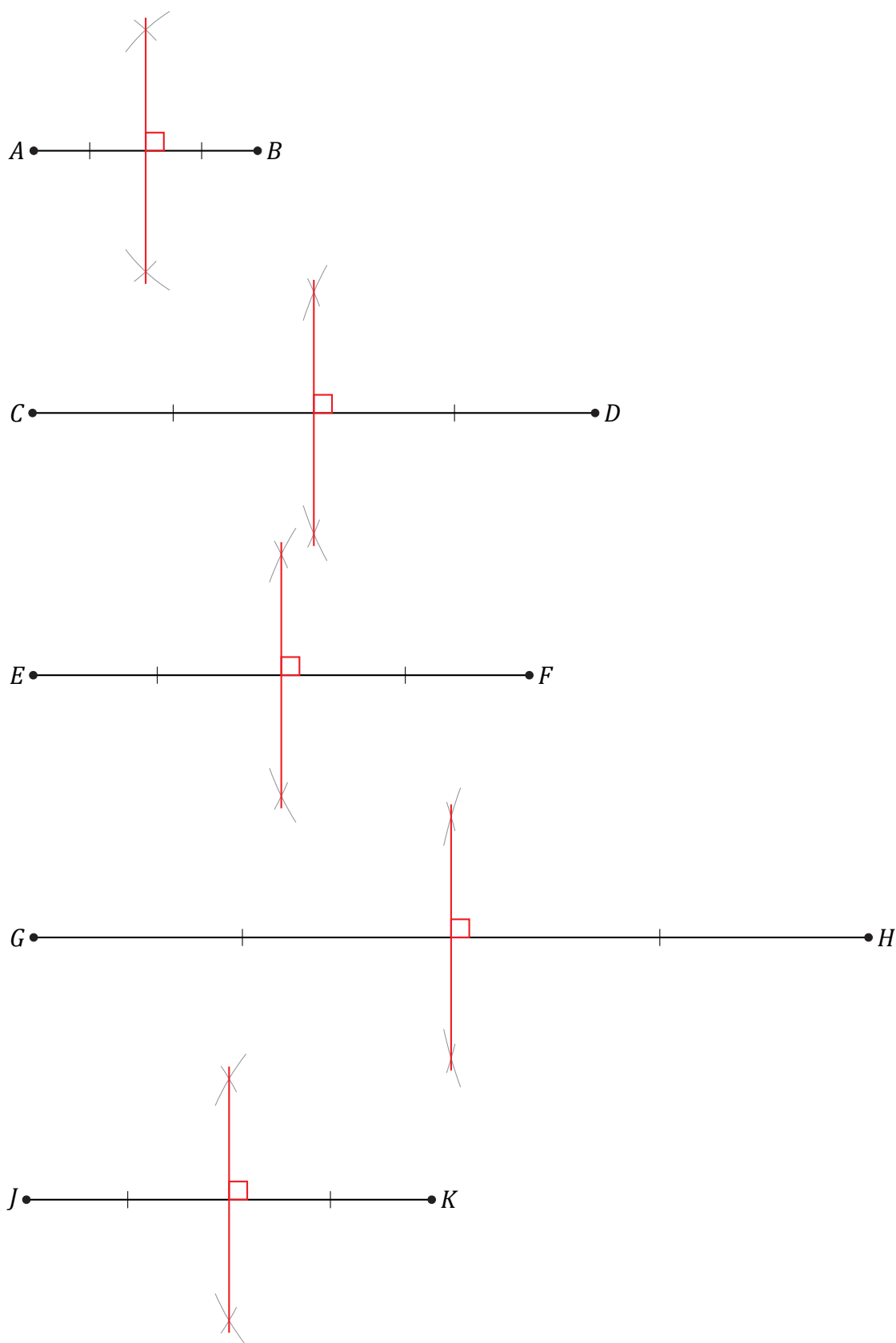

Médiatrice d'un Segment (D)

Nom: _____

Date: _____

Construisez la médiatrice à l'aide d'une règle et un compas.

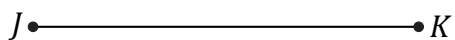
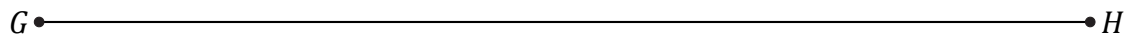
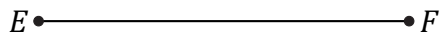
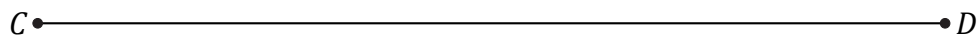
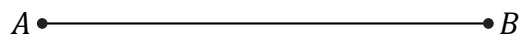

Médiatrice d'un Segment (D) Réponses

Nom: _____

Date: _____

Construisez la médiatrice à l'aide d'une règle et un compas.

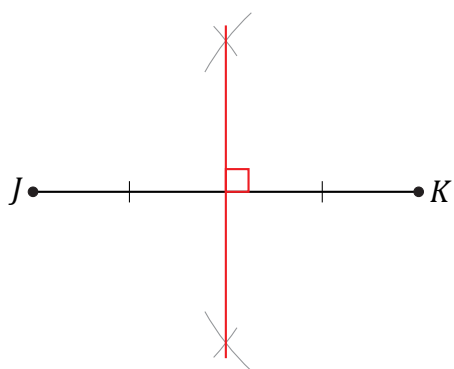
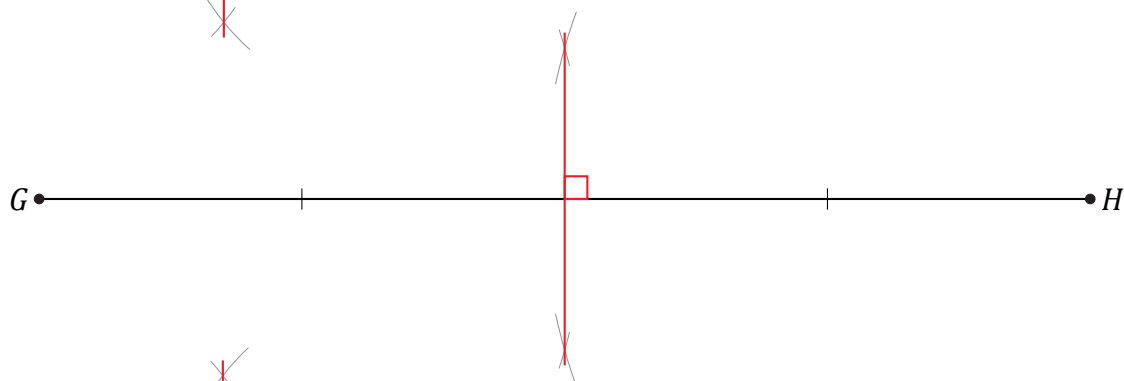
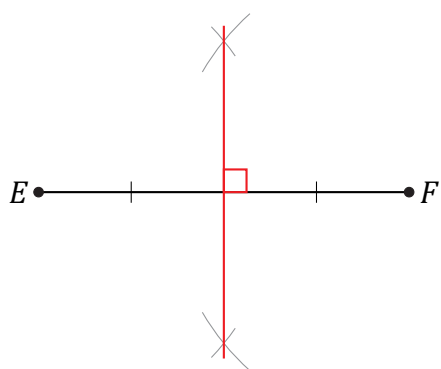
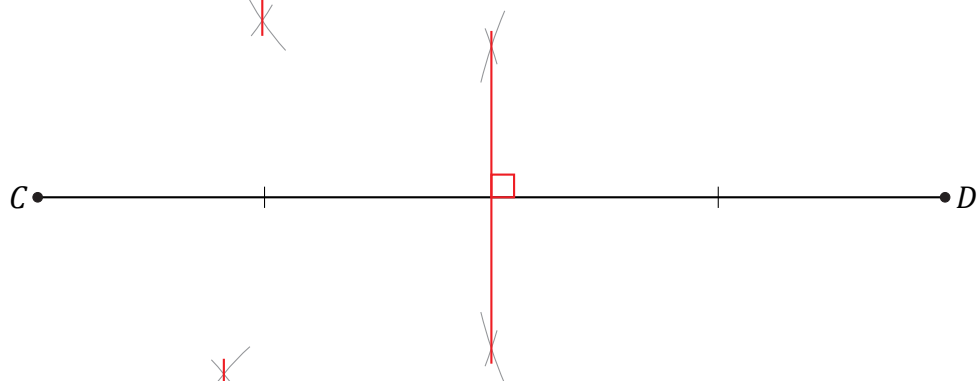
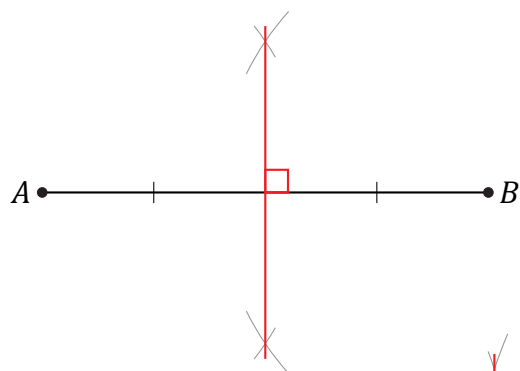

Médiatrice d'un Segment (E)

Nom: _____

Date: _____

Construisez la médiatrice à l'aide d'une règle et un compas.

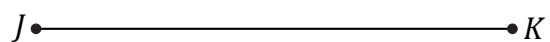
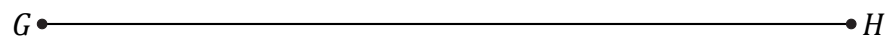
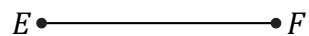
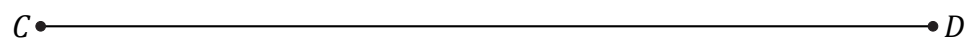
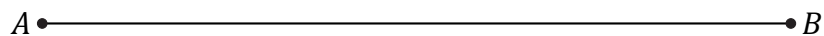

Médiatrice d'un Segment (E) Réponses

Nom: _____

Date: _____

Construisez la médiatrice à l'aide d'une règle et un compas.

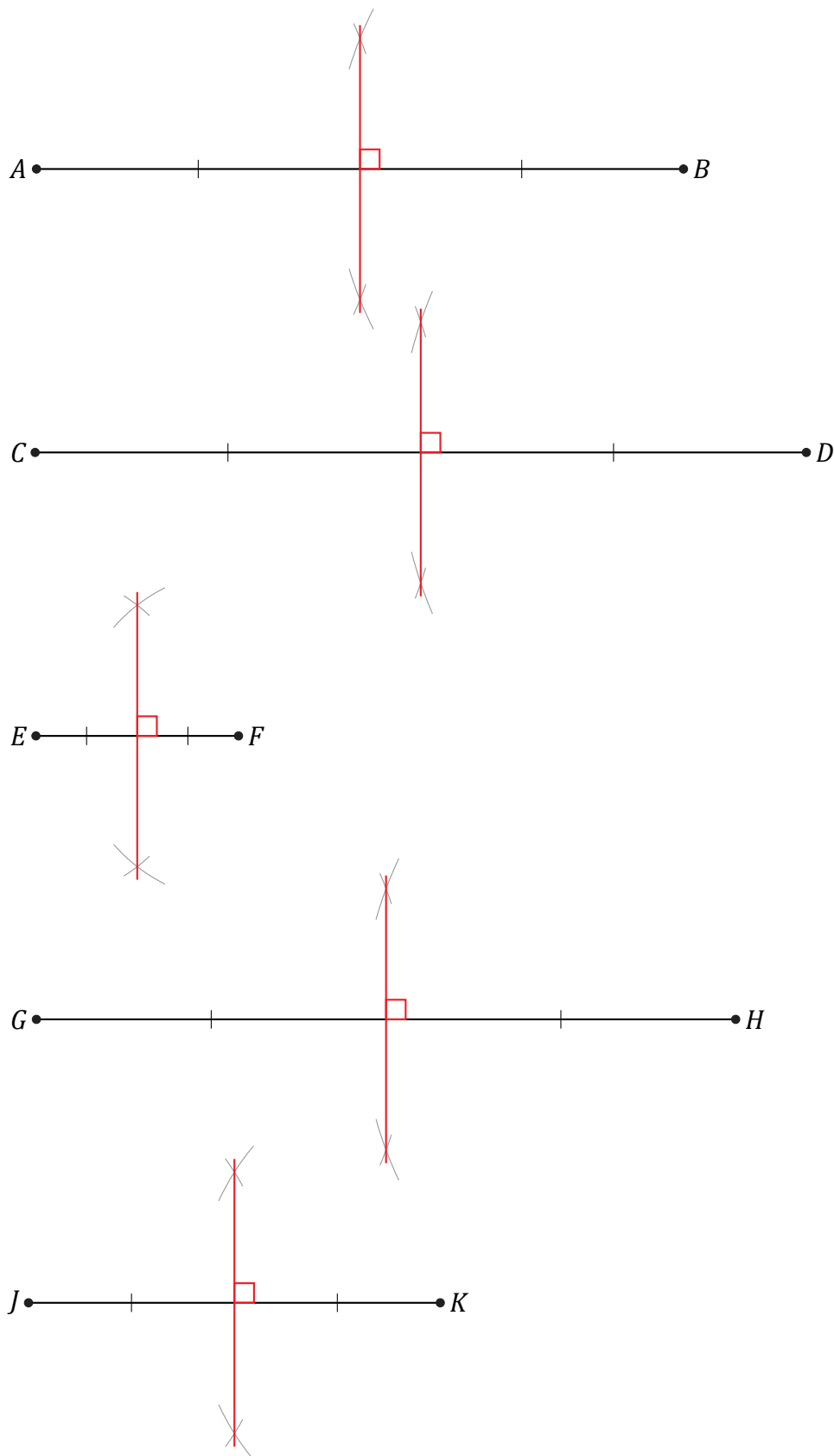

Médiatrice d'un Segment (F)

Nom: _____

Date: _____

Construisez la médiatrice à l'aide d'une règle et un compas.

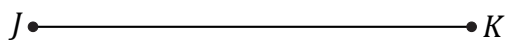
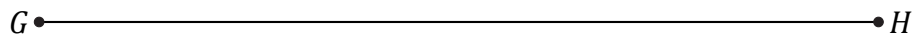
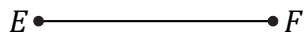
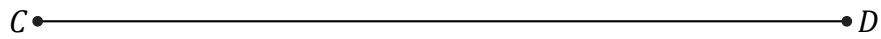

Médiatrice d'un Segment (F) Réponses

Nom: _____

Date: _____

Construisez la médiatrice à l'aide d'une règle et un compas.

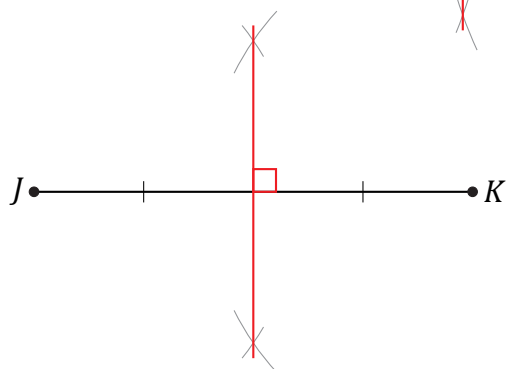
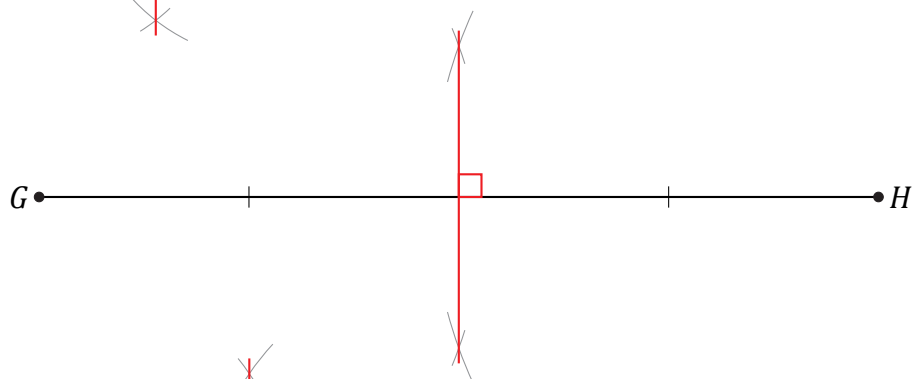
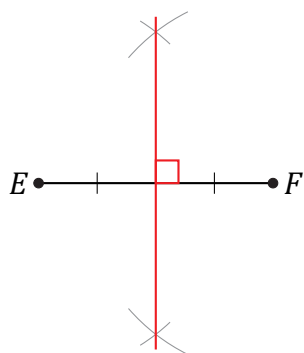
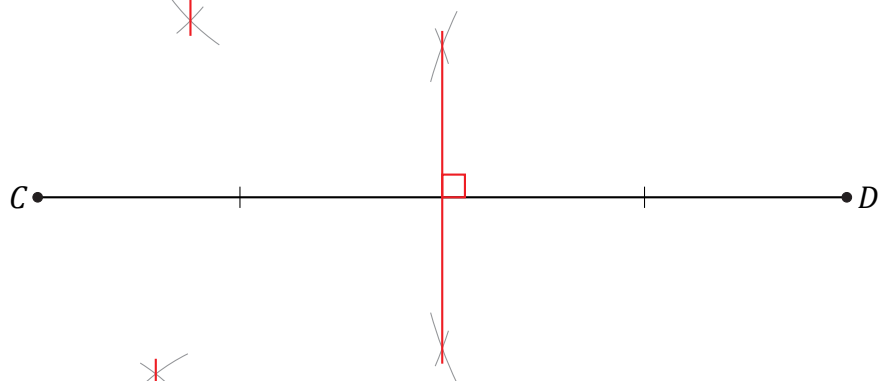
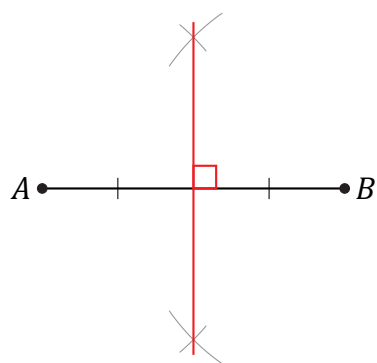

Médiatrice d'un Segment (G)

Nom: _____

Date: _____

Construisez la médiatrice à l'aide d'une règle et un compas.

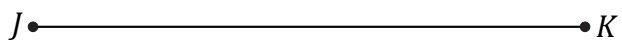
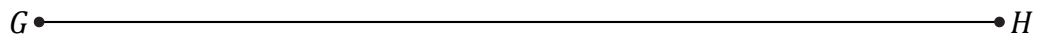
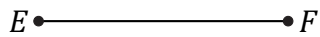
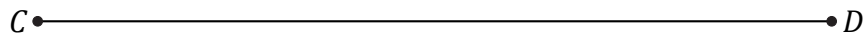

Médiatrice d'un Segment (G) Réponses

Nom: _____

Date: _____

Construisez la médiatrice à l'aide d'une règle et un compas.

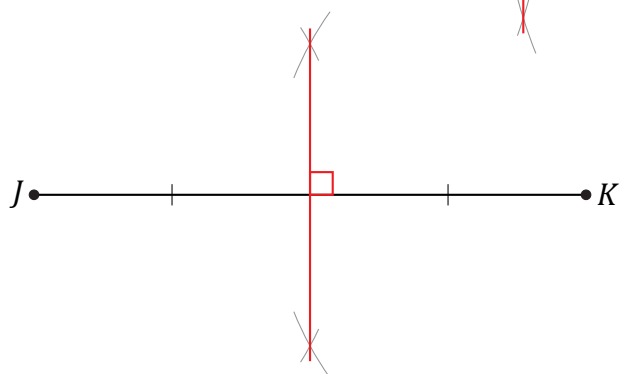
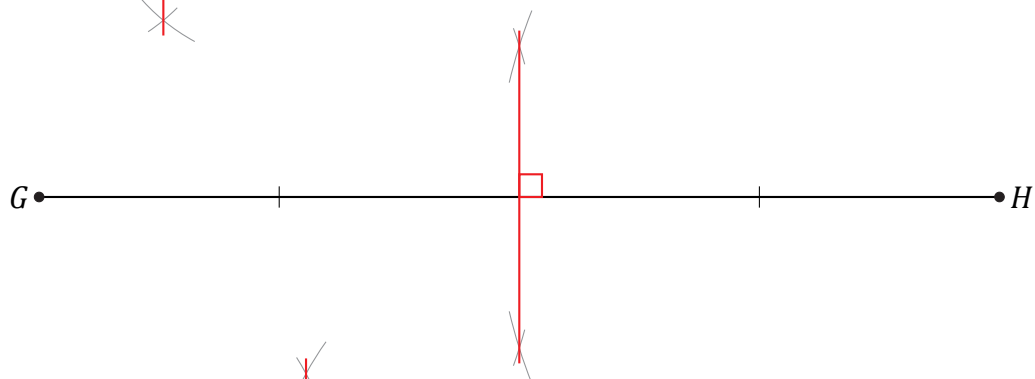
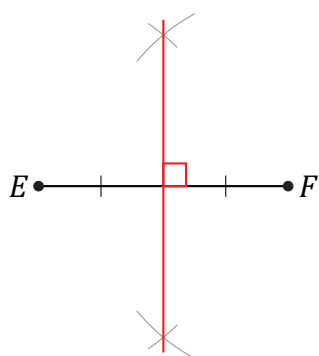
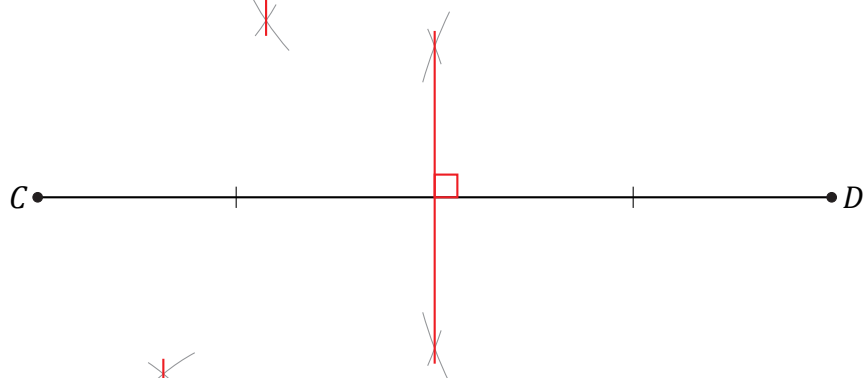
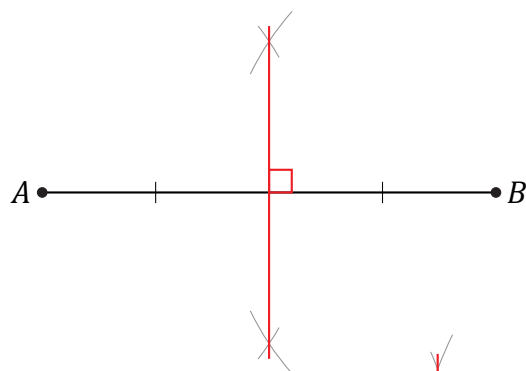

Médiatrice d'un Segment (H)

Nom: _____

Date: _____

Construisez la médiatrice à l'aide d'une règle et un compas.

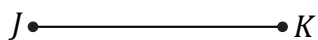
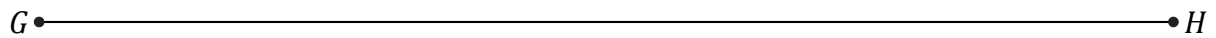
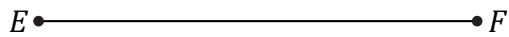
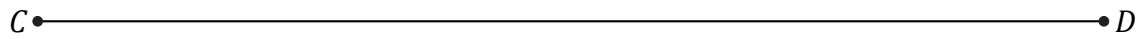
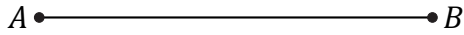

Médiatrice d'un Segment (H) Réponses

Nom: _____

Date: _____

Construisez la médiatrice à l'aide d'une règle et un compas.

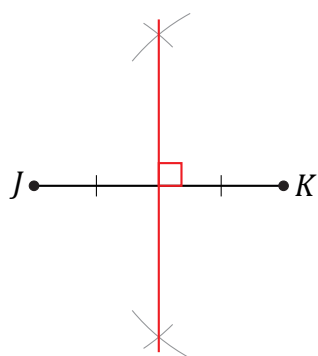
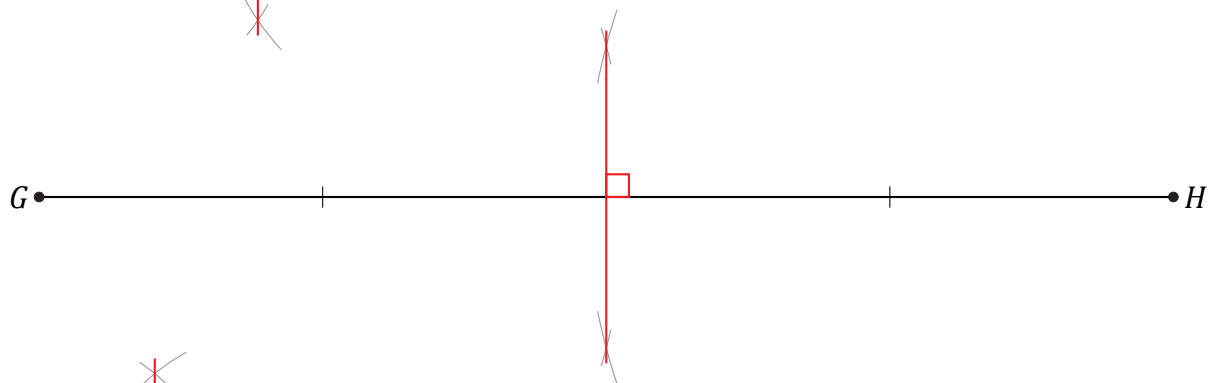
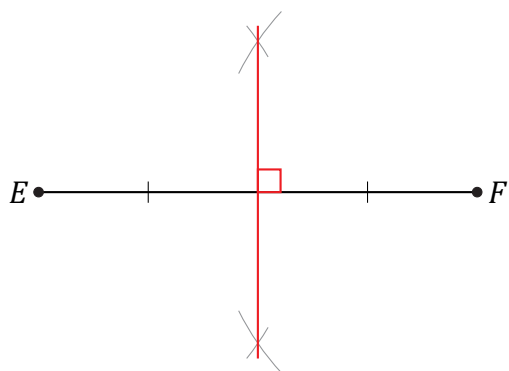
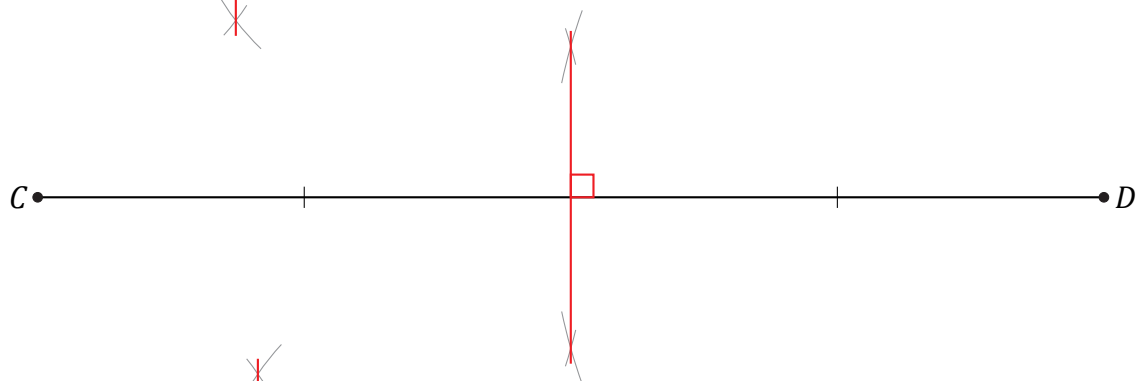
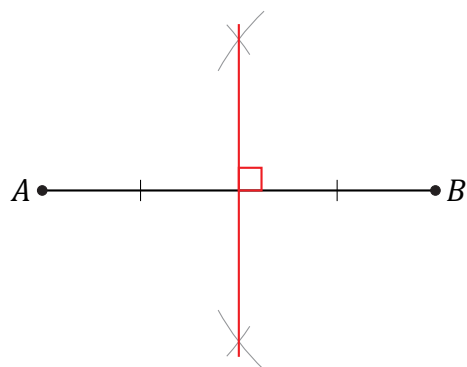

Médiatrice d'un Segment (I)

Nom: _____

Date: _____

Construisez la médiatrice à l'aide d'une règle et un compas.

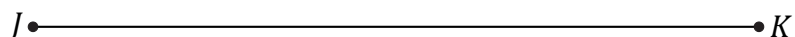
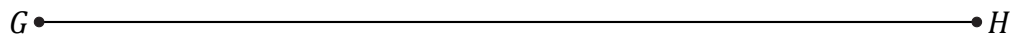
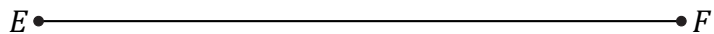
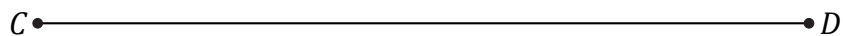
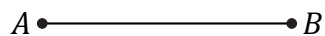

Médiatrice d'un Segment (I) Réponses

Nom: _____

Date: _____

Construisez la médiatrice à l'aide d'une règle et un compas.

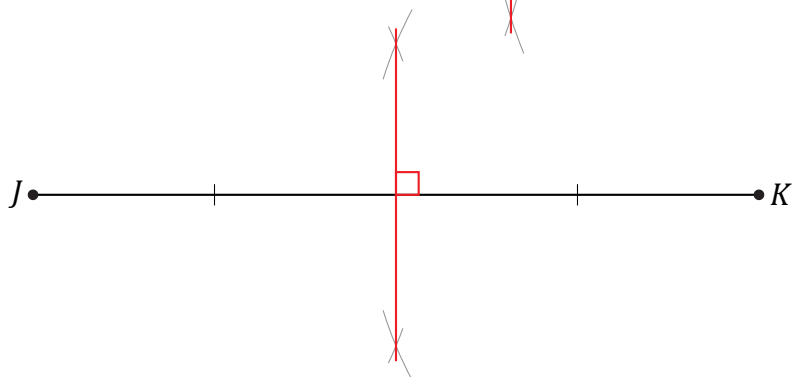
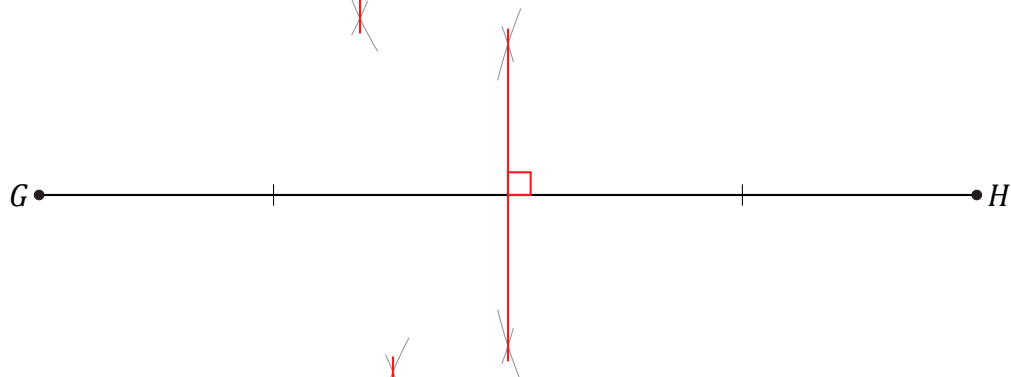
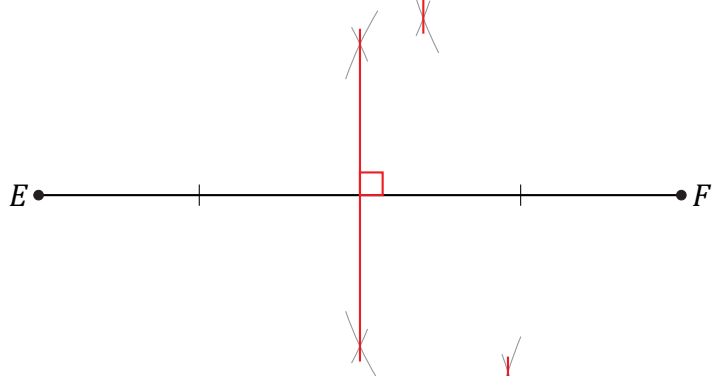
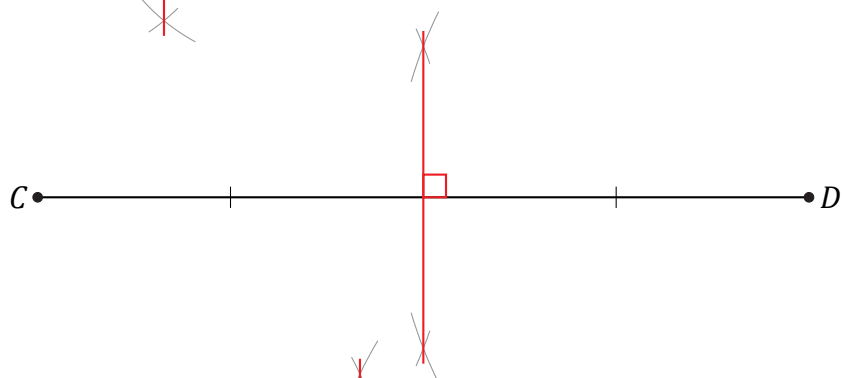
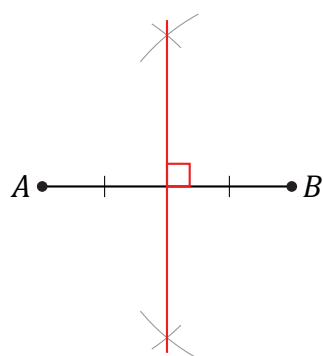

Médiatrice d'un Segment (J)

Nom: _____

Date: _____

Construisez la médiatrice à l'aide d'une règle et un compas.

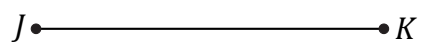
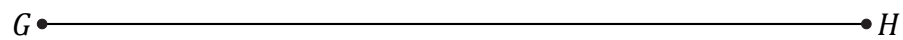
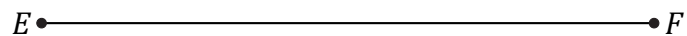
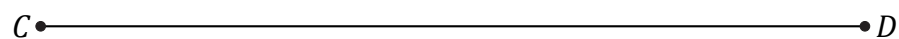
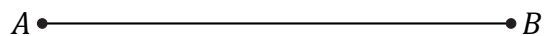

Médiatrice d'un Segment (J) Réponses

Nom: _____

Date: _____

Construisez la médiatrice à l'aide d'une règle et un compas.

