

# Lignes Perpendiculaires (A)

Construisez une ligne perpendiculaire au segment passant par le point sans étiquette.

1.



2.

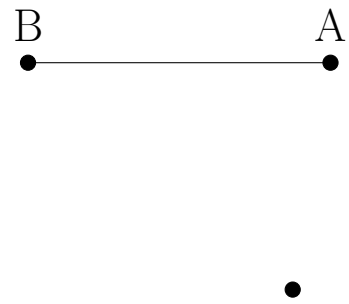

3.

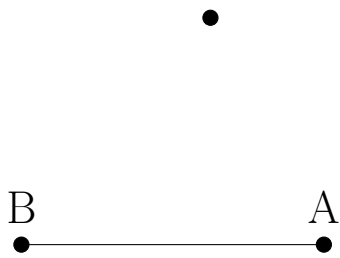

4.

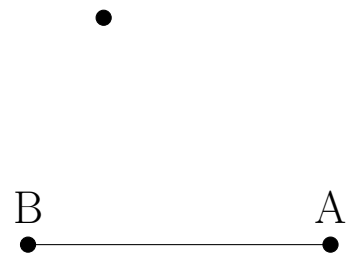

# Lignes Perpendiculaires (A) Solutions

Construisez une ligne perpendiculaire au segment passant par le point sans étiquette.

1.

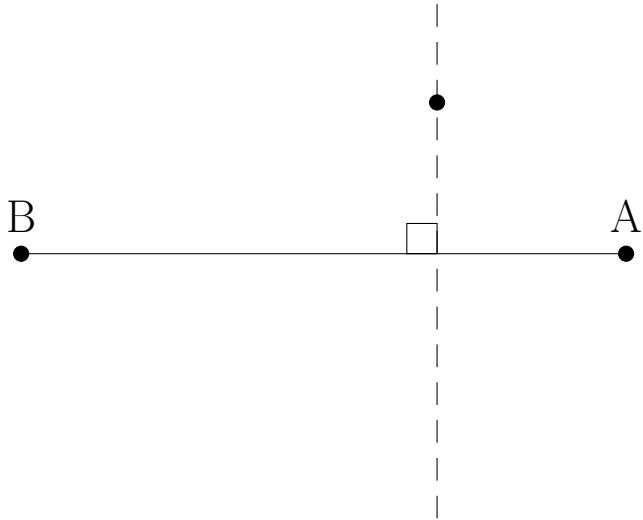

2.

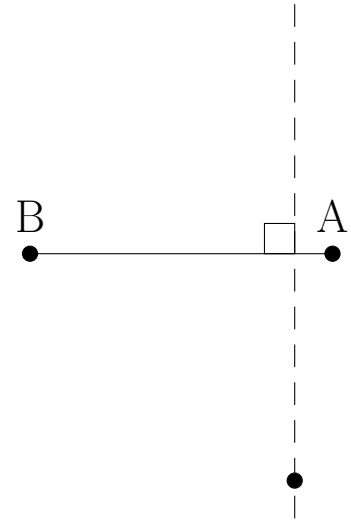

3.

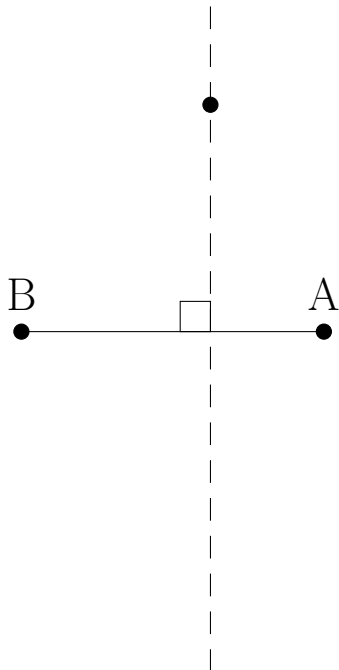

4.

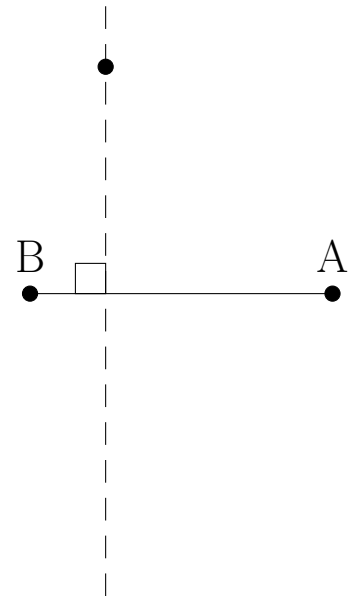

# Lignes Perpendiculaires (B)

Construisez une ligne perpendiculaire au segment passant par le point sans étiquette.

1.

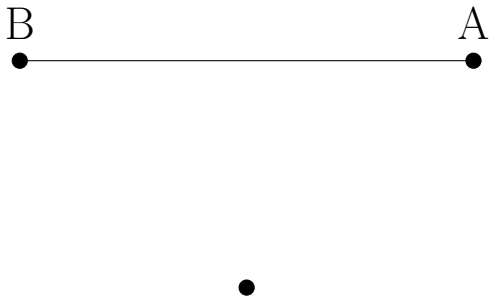

2.



3.

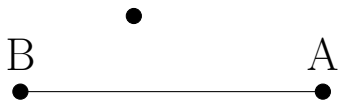

4.

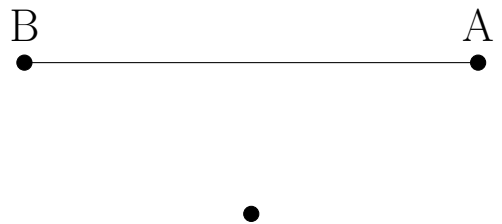

## Lignes Perpendiculaires (B) Solutions

Construisez une ligne perpendiculaire au segment passant par le point sans étiquette.

1.

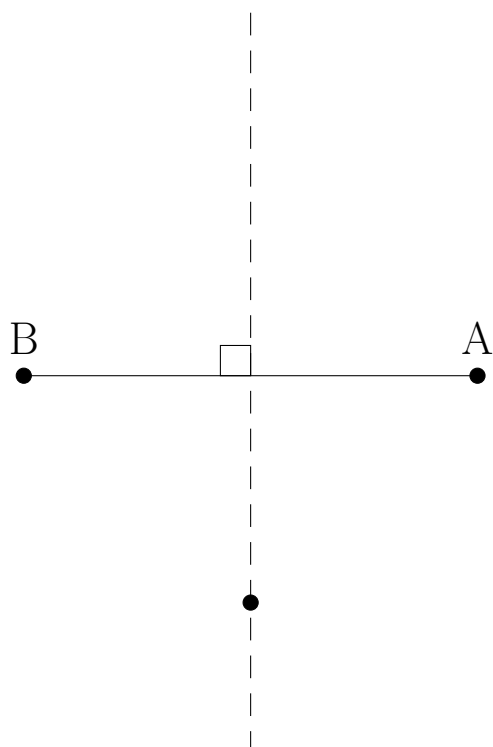

2.

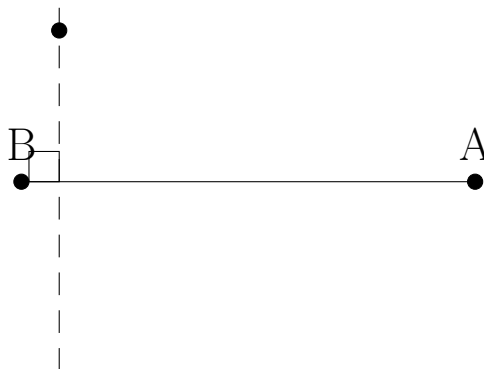

3.

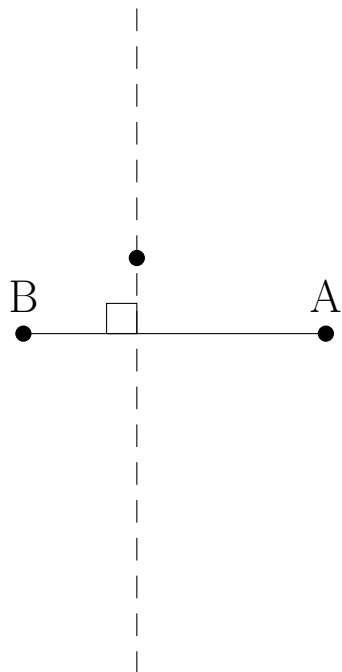

4.

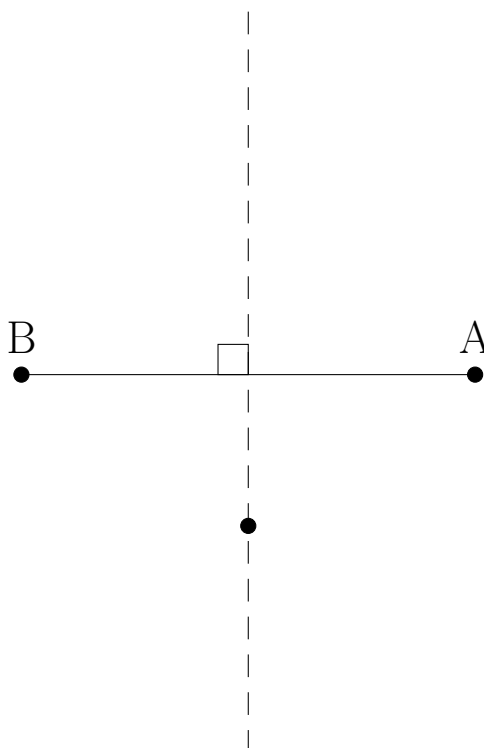

# Lignes Perpendiculaires (C)

Construisez une ligne perpendiculaire au segment passant par le point sans étiquette.

1.



2.



3.

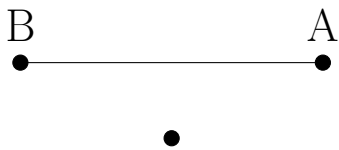

4.

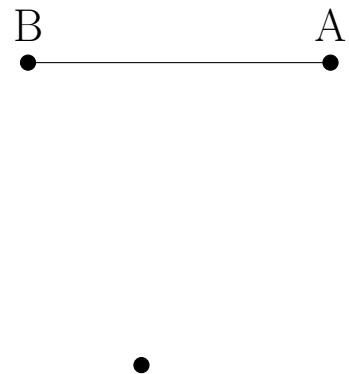

# Lignes Perpendiculaires (C) Solutions

Construisez une ligne perpendiculaire au segment passant par le point sans étiquette.

1.

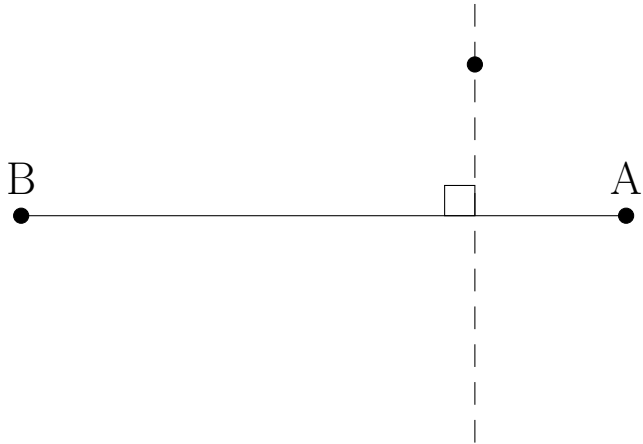

2.

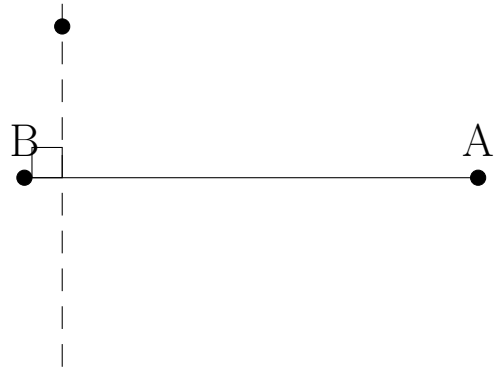

3.

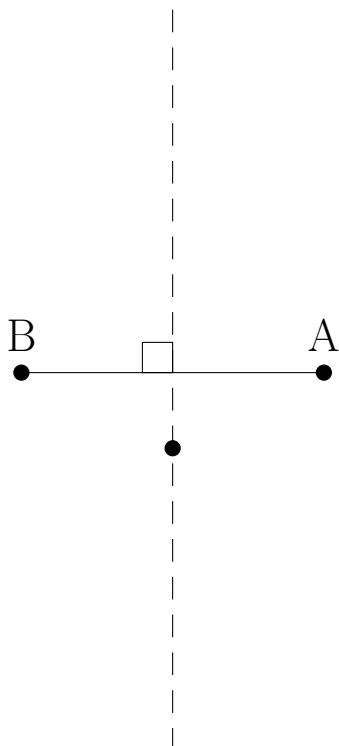

4.

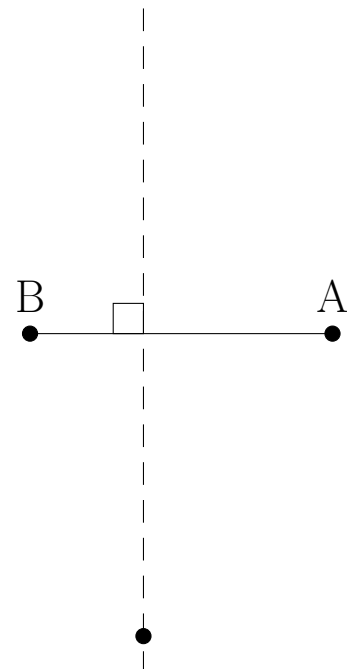

# Lignes Perpendiculaires (D)

Construisez une ligne perpendiculaire au segment passant par le point sans étiquette.

1.

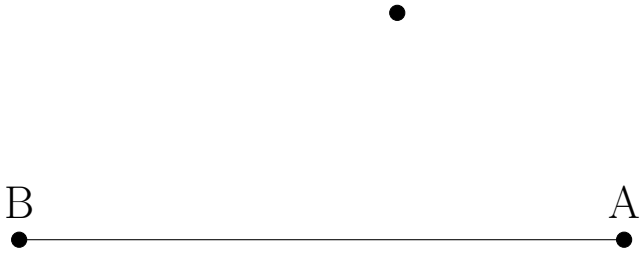

2.

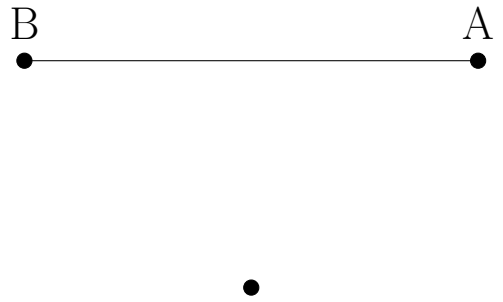

3.

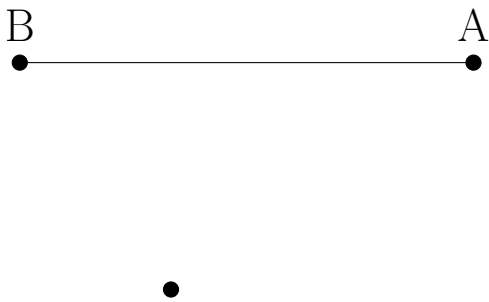

4.

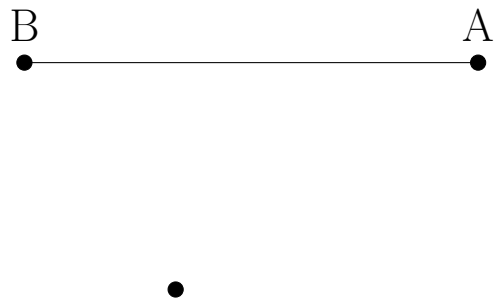

# Lignes Perpendiculaires (D) Solutions

Construisez une ligne perpendiculaire au segment passant par le point sans étiquette.

1.

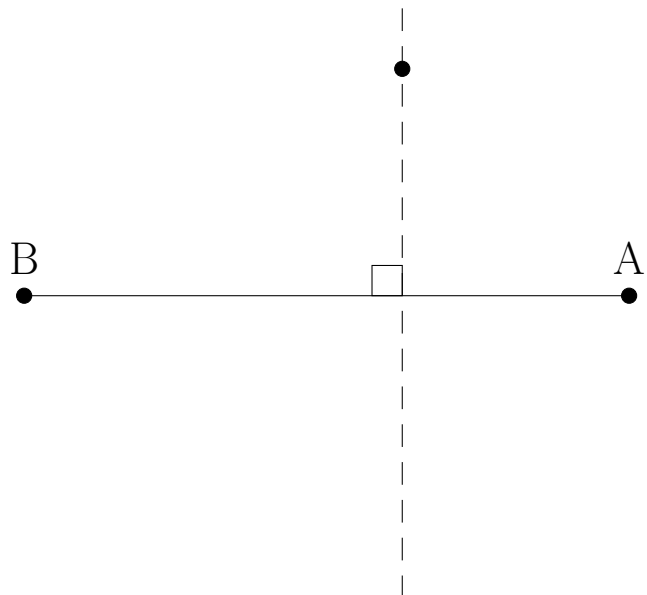

2.

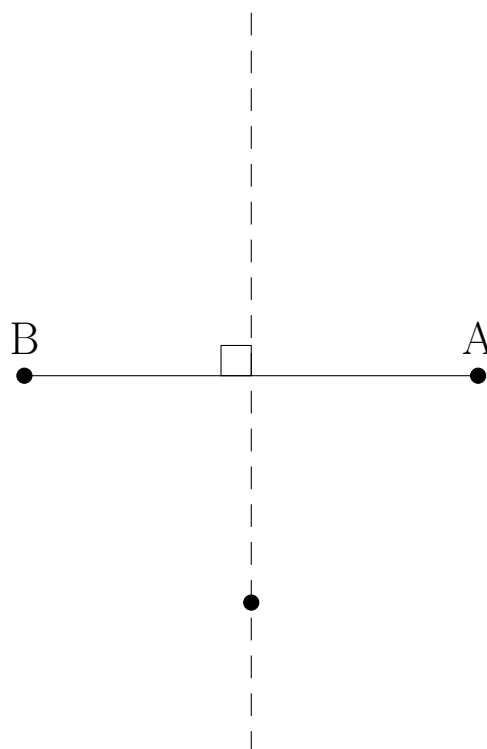

3.

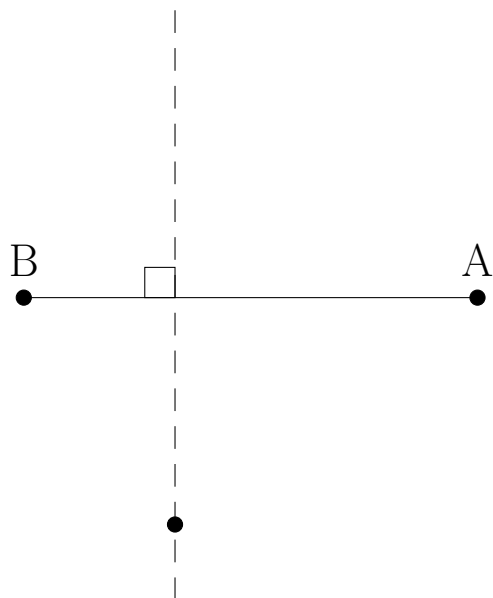

4.

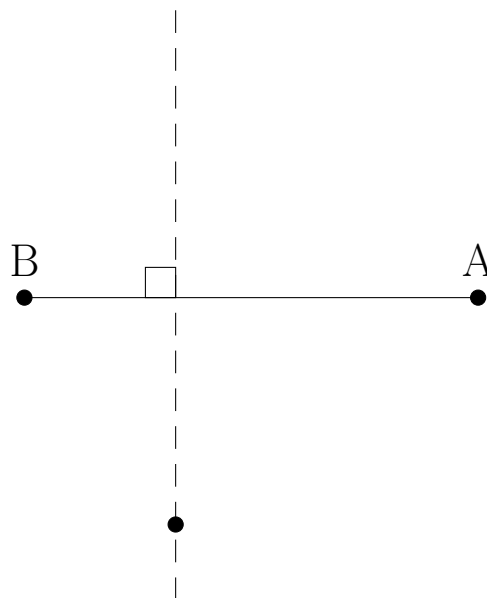



# Lignes Perpendiculaires (E)

Construisez une ligne perpendiculaire au segment passant par le point sans étiquette.

1.



2.

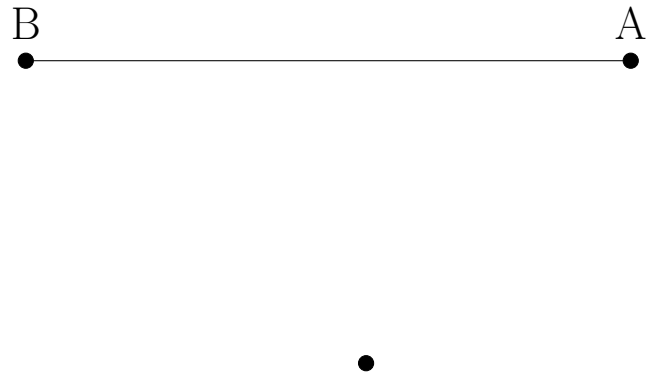

3.



4.

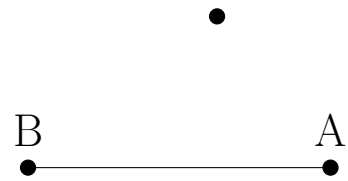

# Lignes Perpendiculaires (E) Solutions

Construisez une ligne perpendiculaire au segment passant par le point sans étiquette.

1.

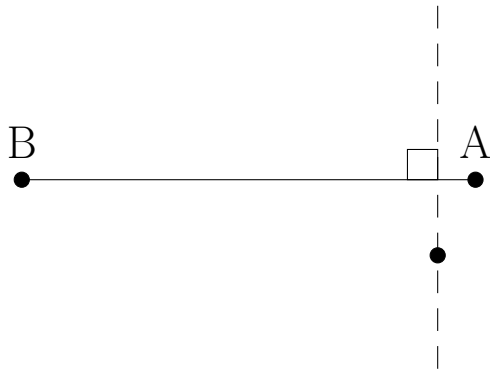

2.

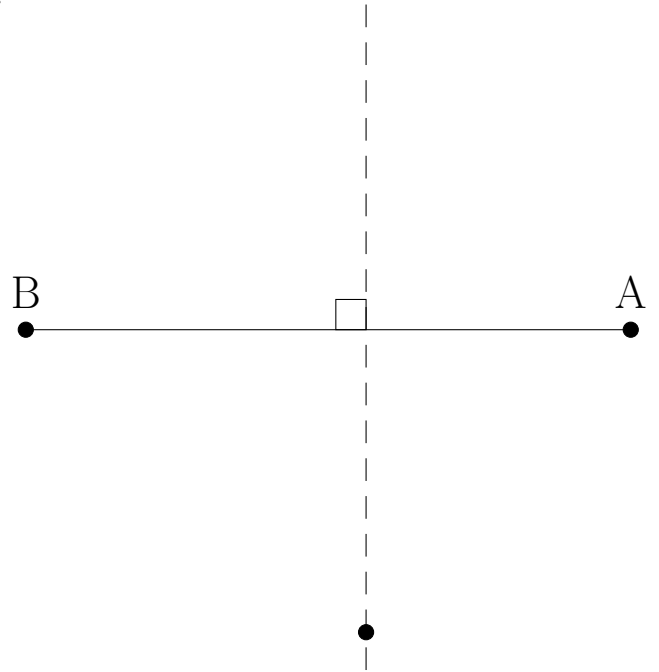

3.

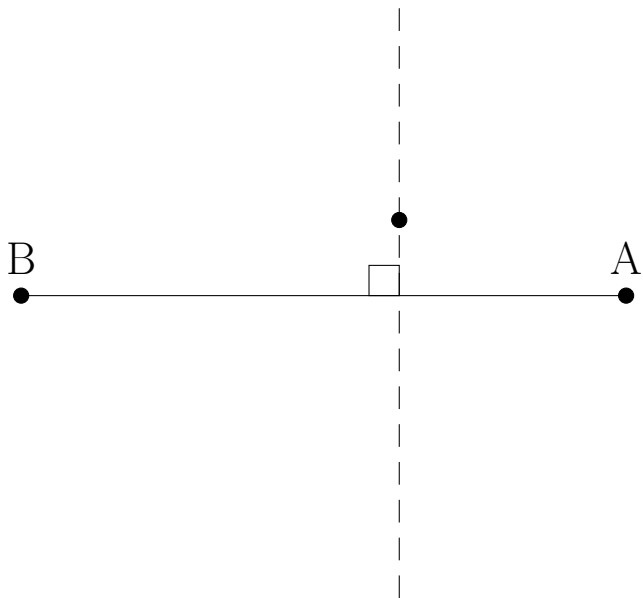

4.

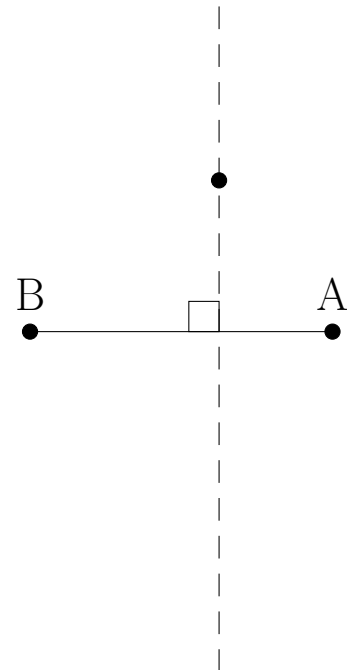

# Lignes Perpendiculaires (F)

Construisez une ligne perpendiculaire au segment passant par le point sans étiquette.

1.

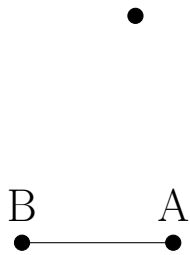

2.

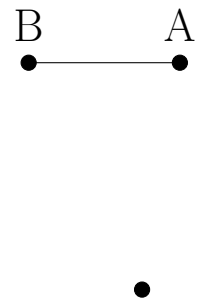

3.



4.

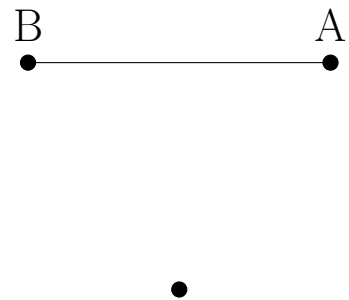

# Lignes Perpendiculaires (F) Solutions

Construisez une ligne perpendiculaire au segment passant par le point sans étiquette.

1.

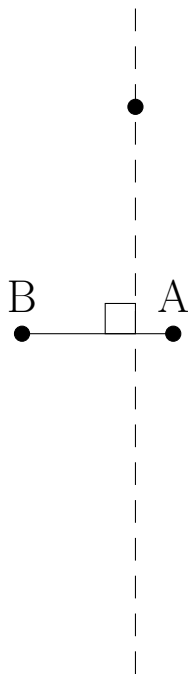

2.

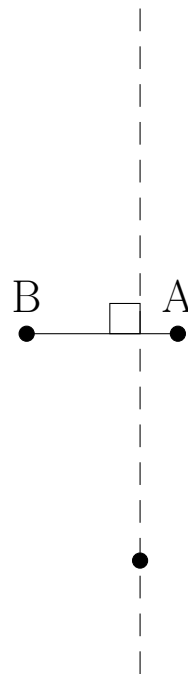

3.

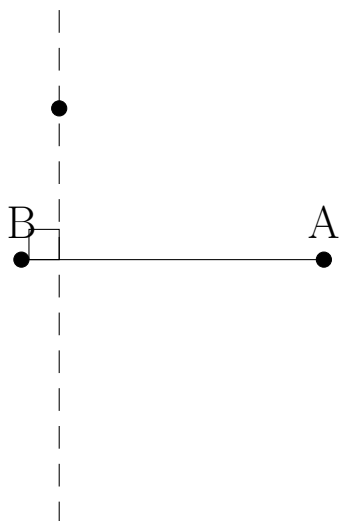

4.

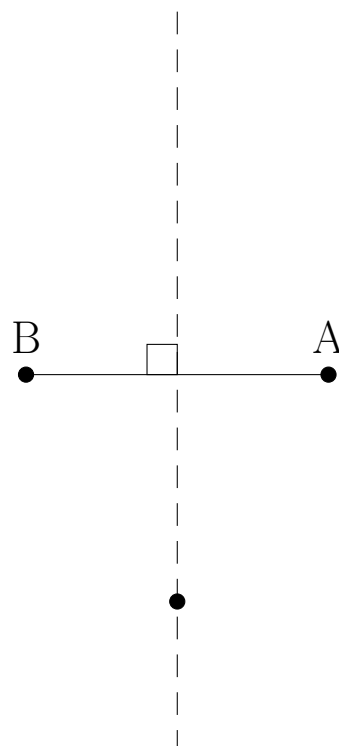

# Lignes Perpendiculaires (G)

Construisez une ligne perpendiculaire au segment passant par le point sans étiquette.

1.



2.



3.



4.



# Lignes Perpendiculaires (G) Solutions

Construisez une ligne perpendiculaire au segment passant par le point sans étiquette.

1.



2.

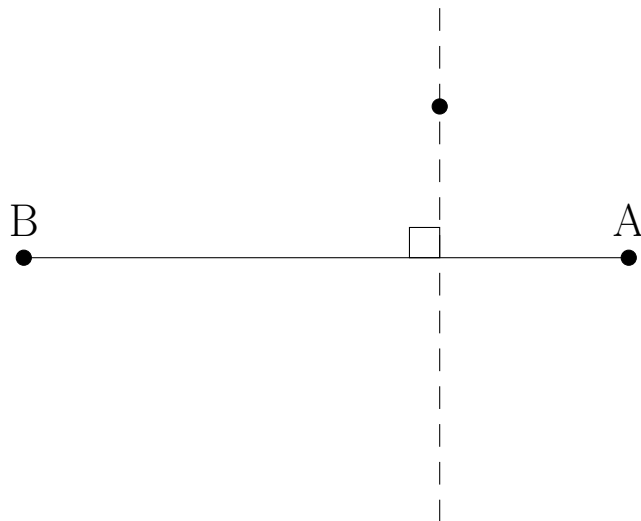

3.

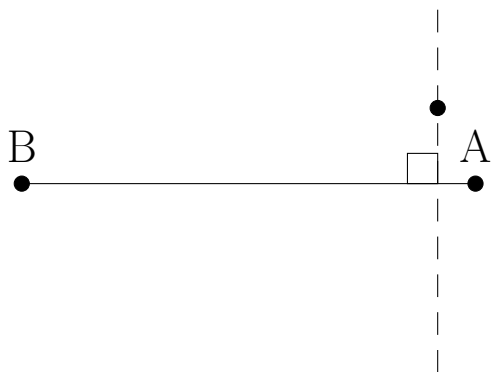

4.



# Lignes Perpendiculaires (H)

Construisez une ligne perpendiculaire au segment passant par le point sans étiquette.

1.

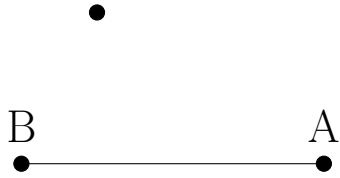

2.

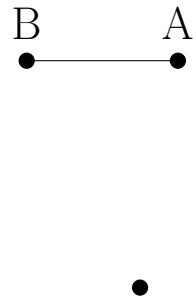

3.



4.



# Lignes Perpendiculaires (H) Solutions

Construisez une ligne perpendiculaire au segment passant par le point sans étiquette.

1.

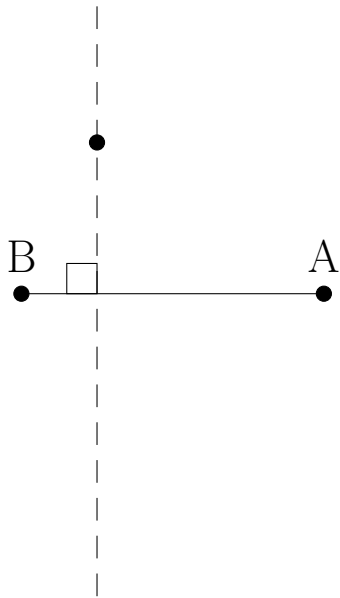

2.

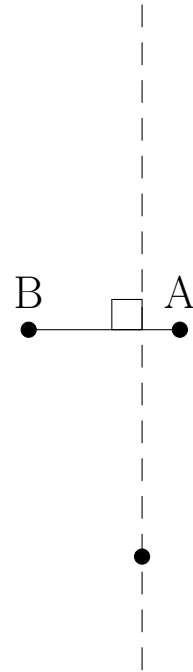

3.

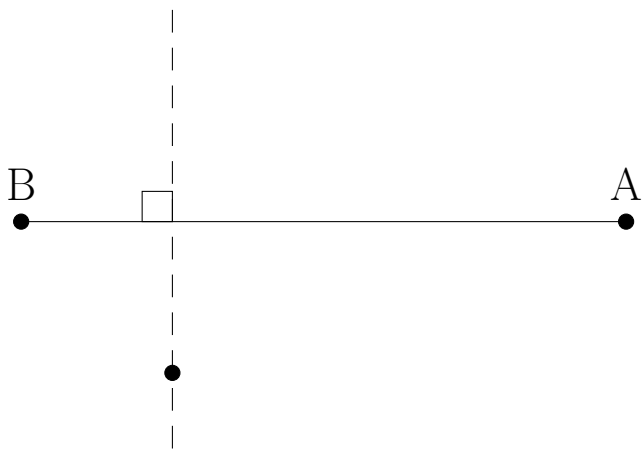

4.





# Lignes Perpendiculaires (I)

Construisez une ligne perpendiculaire au segment passant par le point sans étiquette.

1.



2.

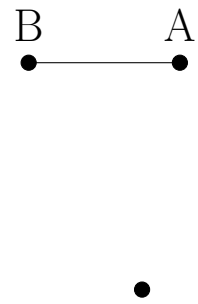

3.



4.



# Lignes Perpendiculaires (I) Solutions

Construisez une ligne perpendiculaire au segment passant par le point sans étiquette.

1.

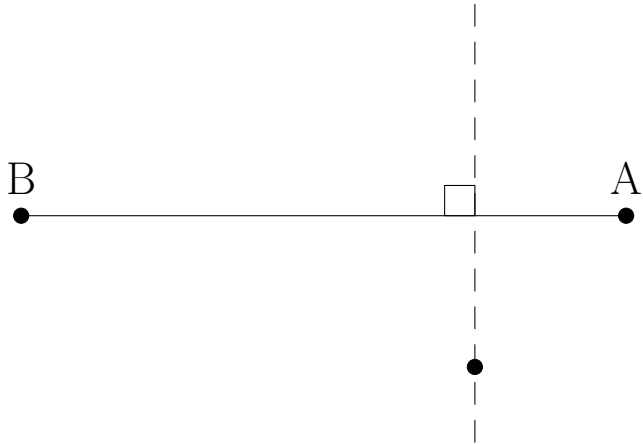

2.

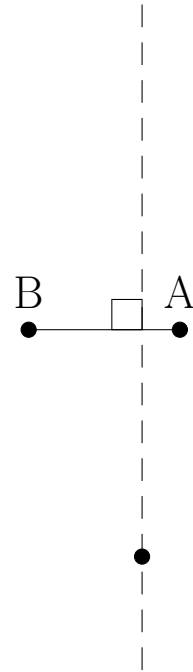

3.

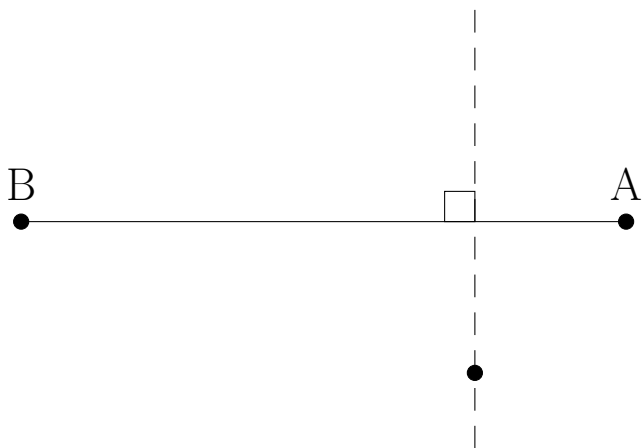

4.

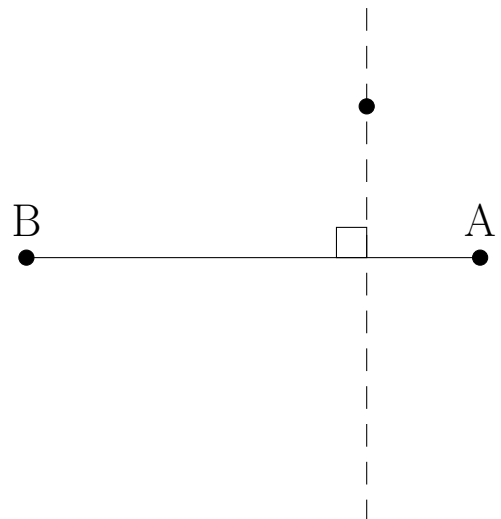

# Lignes Perpendiculaires (J)

Construisez une ligne perpendiculaire au segment passant par le point sans étiquette.

1.

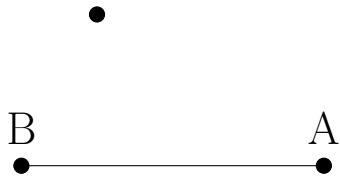

2.

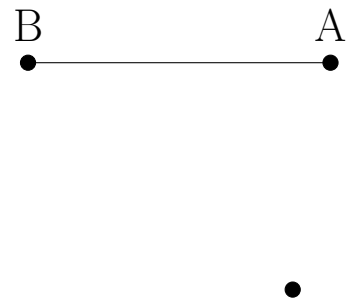

3.

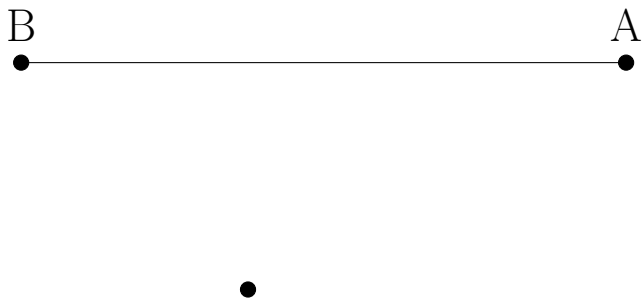

4.

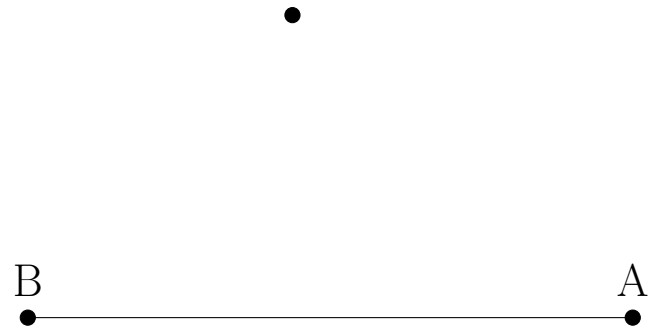

# Lignes Perpendiculaires (J) Solutions

Construisez une ligne perpendiculaire au segment passant par le point sans étiquette.

1.

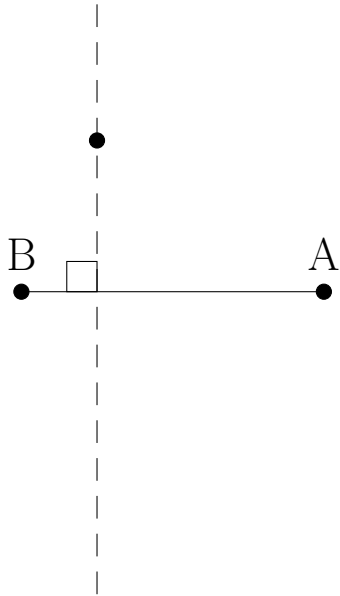

2.

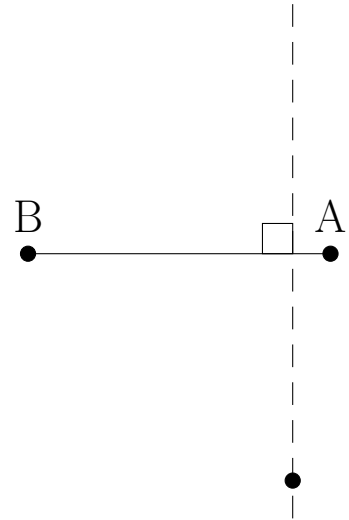

3.

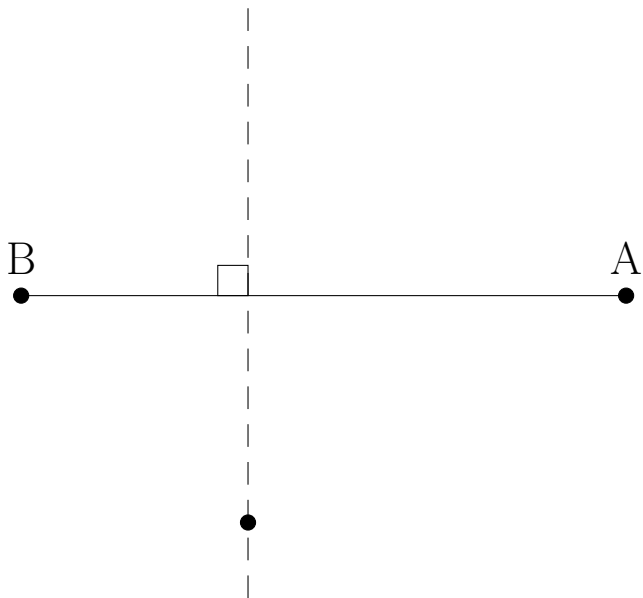

4.

